



Supporting Healthcare Transformation Worldwide



www.pintech.com.pk

Company Profile:

Pin Tech Instruments a well known name in the field of dental, measuring & Calibration instruments since 1977. The company is involved in the manufacturing activities, now has decided to plunge into export business. We are located in Sialkot, the industrial city of Pakistan. Renown for its Medical Instruments, Leather Products & Sports Goods, Skilled labor of the Sialkot has the experience of two generation to make the steel into useful tools, now with the modern machinery and new techniques it become even more superior. Our products have a great reputation and competitive price in domestic and foreign market.

The Materials

Pin Tech Instruments always selects the finest material. The material selected has the appropriate hardness and flexibility, including the highest grade of surgical steel. According to Pin Tech's point of view, instrument made with inferior material may be cheaper initially but will cost more in the long run.

The Craftsmen

Pin Tech Instruments has its own in house makers who have inherited skills, which are further supported by latest approaches. These makers are specialized in different functions.

The design & development

Pin Tech Instruments has its own designs for different instruments. The design and development activity of all these instruments is carried out following the design and development clause of ISO 9001:2008

Quality Control

Keeping in view the nature of instruments, Pin Tech Instruments has applied quality checks to ensure that only the finest quality is produced. Strict measures are taken right from the forgings to final approval.

Patterns Consistency

Pin Tech Instruments hundred percent quality control specialized workforce and use of precise machine tools make it possible that all instruments will be consistent in shape and size year after year.

Membership/Certificates





Special

Additional Services

- Ask for your own customized dental instruments, you can design and develop your own instruments in collaboration with PIN TECH INSTRUMENTS.
- We offer a repair-service for our dental and surgical instruments

Articulators:	Page 01 to 04
Dental Lab Instruments:	Page 05 to 06
Dental, Ear & Veterinary Syringes:	Page 07 to 10
Crown Removers	Page 11 to 12

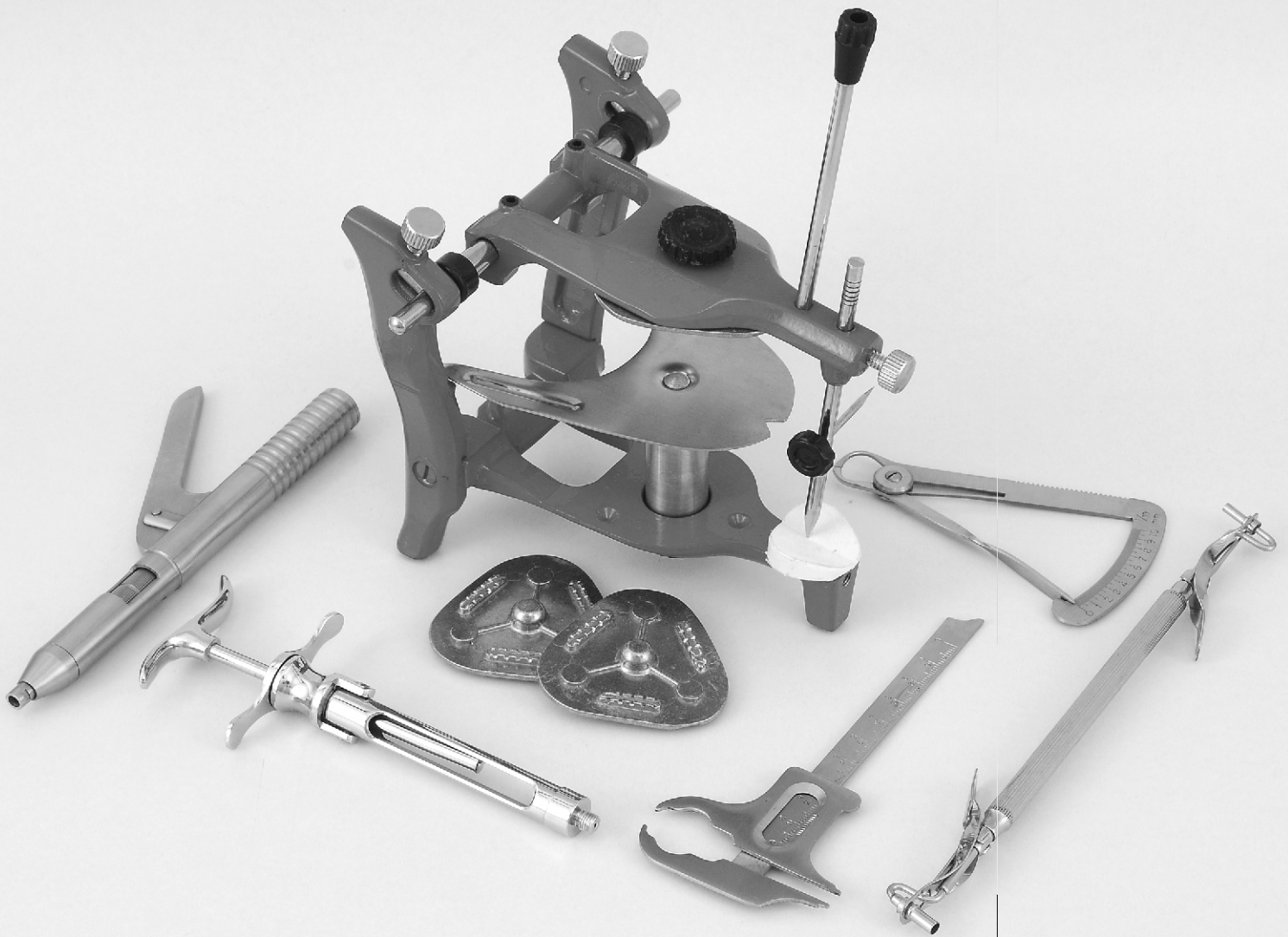

FEATURE INSTRUMENTS

Articulators



100-01

High Tech Plasterless Articulator Galetti With Adjustable Screws At Rears & Front. All Anatomical Movements Possible Also available in Vibratory polished

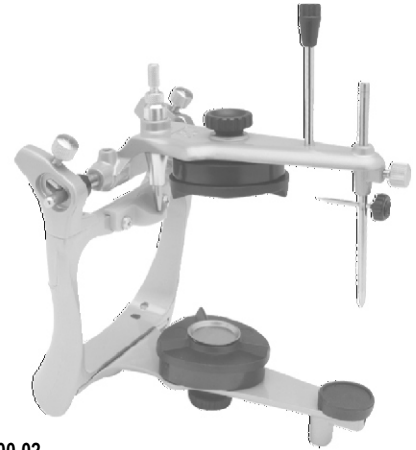

100-02

Semi Anatomical Silver Articulator High Tech. Adjustable Back Rod By Registration Screw To Work Without Incisal Rod By Keeping Constant Trajectories And Inclinations During Side And Back/ Forward Movements. Pure Translation Movement Anti-shock Hinge Rod In Case Articulator Falls Accidentally. Bigger Size Lock Screws For Mounting Plates



100-03

Gnatus Pro JP30 Articulator Best Performance With An Excellent Degree Of Accuracy. Its Functionality Makes Easier Both The Procedures Of Taking & Transferring The Patient's Records & The Process Of Mounting The Models

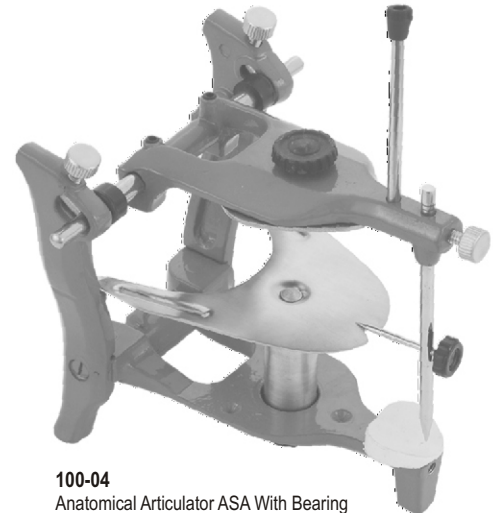

100-04

Anatomical Articulator ASA With Bearing Rod & Incisive Pin - Solidly Constructed Of Metal Alloy Casting. Available In Assorted Colors

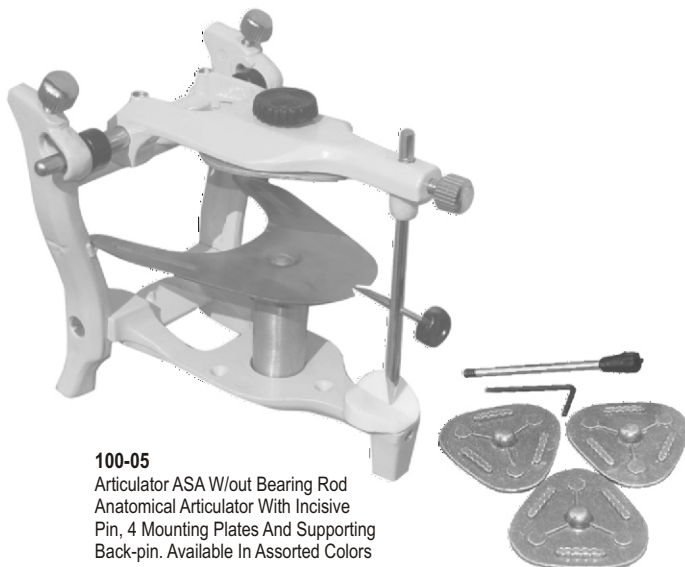

100-05

Articulator ASA W/out Bearing Rod Anatomical Articulator With Incisive Pin, 4 Mounting Plates And Supporting Back-pin. Available In Assorted Colors



100-06

ASA Articulator With Lateral Moment. Made Of Aluminum Die Casting With 2 Mounting Plates. Also Available In Vibratory Polished Process & Assorted colors



100-07
Keystone Deluxe Magnetic Denture Articulator With Plates, Interchangeable, Incisal Pin Included. Magnetic Split Casting Ensures Easy & Exact Setting, Lateral Excursions



100-08
Keystone Deluxe Universal Type-A Articulator. Interchangeable, Included Incisal Pin, Lateral Excursions

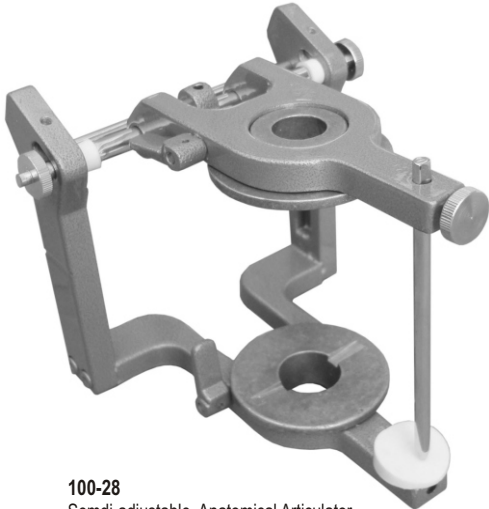

100-28
Semi-adjustable, Anatomical Articulator

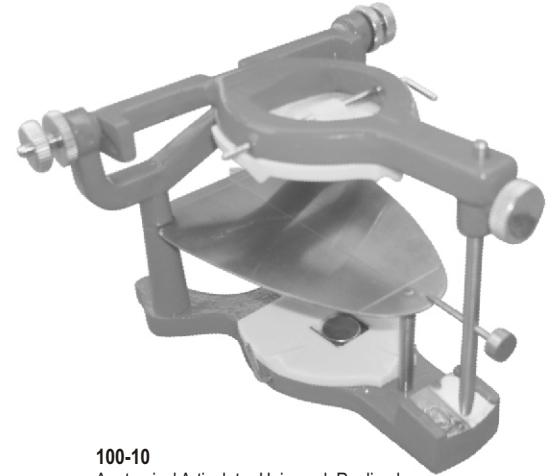

100-10
Anatomical Articulator Universal, Realized For Easy Visibility To The Lingual Surface & For A Perfect Stability Also In Reserved Position. Also available in Assorted Colors



100-11
Mortimer-I Oculader Articulator Plainline Ball Bearing Mortimer-I Oculader Articulator. All Filled With High Carbon Steel Balls For Smooth Setting & Articulation Of Denture. Also available in Gold Plated.

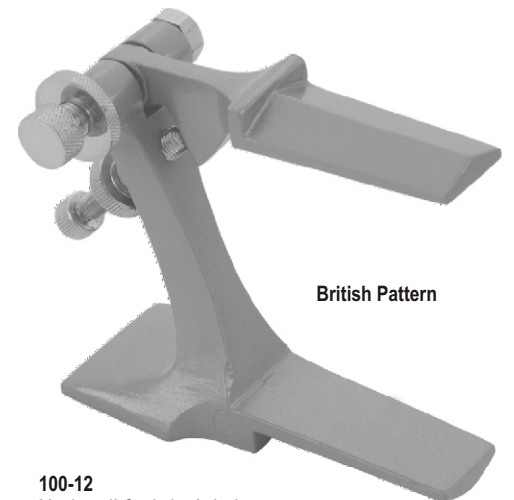

British Pattern

100-12
Mortimer-II Oculader Articulator Plainline Ball Bearing Mortimer-II Oculader Articulator. Semiadjustable Articulator Allows The Establishment Of More Accurate Or Customised Lateral & Protrusive As Well As Centric Occlusion. Also Available In Gold Plated

Articulators

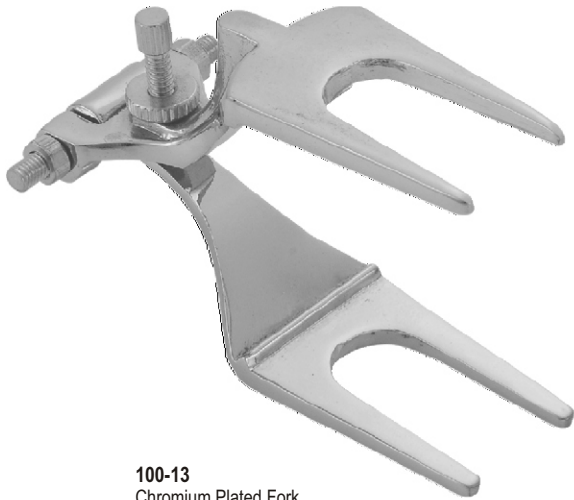

100-13
Chromium Plated Fork
Fork Crowned Bridge Nickel
Chromium Plated Articulator

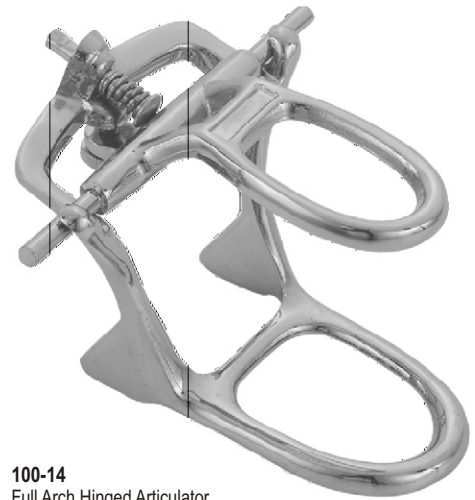

100-14
Full Arch Hinged Articulator
Chromium Plated Hinge Articulator
For Mounting Full Arch Cases. Low
Back. Gypsum-free Articulation Enables
Clean & Accurate Mounting & Dismounting
In 30 Seconds

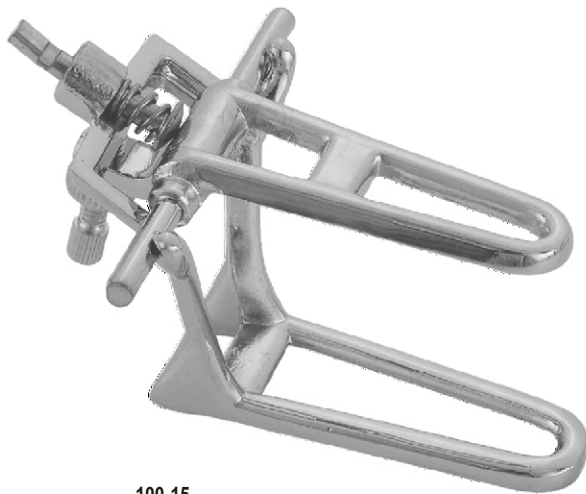

100-15
Ray Foster 57 Chrome Articulator
Chrome Brass Hinge Crowned Bridge
Articulator For Mounting Quadrant Cases.
Crown & Bridge Articulator Is Popular Ray
Foster # 57 Design, Eliminates The Need
To Break Off Models



100-16
Ray Foster 60 Crown & Bridge Spring Articulator
is Unique Articulator, Allows Total Flexibility When
Applying Protrusive & Lateral Movements



100-17
Occlusor, Wire Articulator, Available
In 2 Sizes, Small & Large

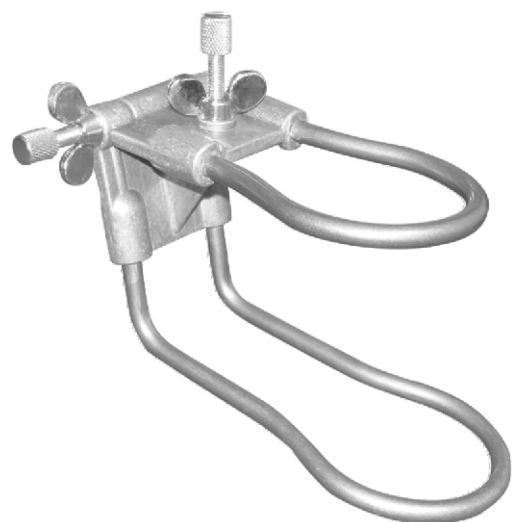

100-18
Vibratory Polished Wire Articulator – Made Of
Stainless Steel & Die Cast Aluminum



100-19
Magic Art-I Articulator Lightweight, High-quality Magic Art Articulator Securely Holds Quadrant Models, Conserve Materials & Time! Quickly & Easily Mount Pre-Cast Dental Models With The High Quality



100-20
Magic Art-II Articulator
Lightweight, High-quality Magic Art Articulator Securely Holds Quadrant Models, Conserve Materials & Time! Quickly & Easily Mount Pre-cast Dental Models With The High Quality

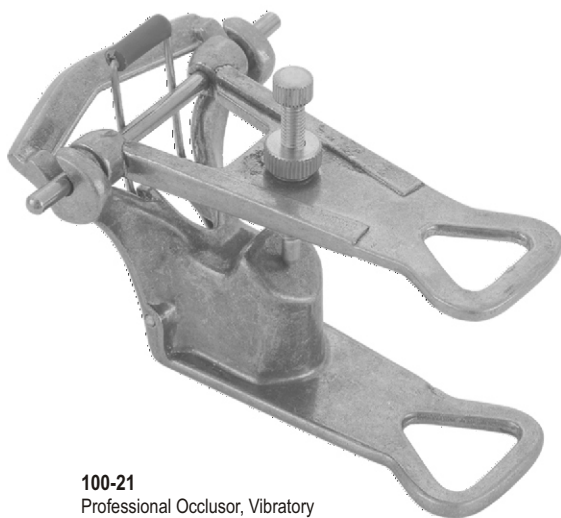

100-21
Professional Occlusor, Vibratory Polished Articulator.

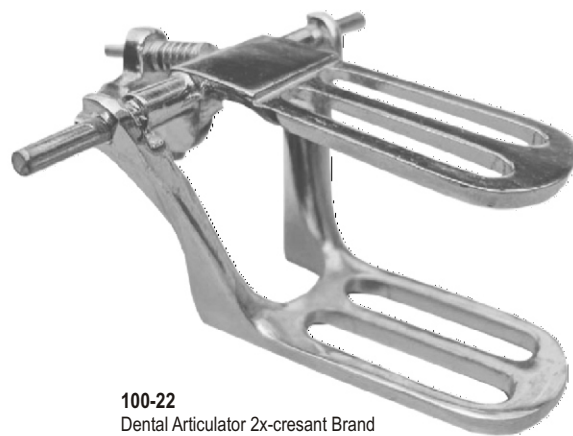

100-22
Dental Articulator 2x-cresant Brand Full Denture Chromium Plated Articulator. Provides Additional Vertical Dimension For Acceptance Of Higher Models. 49 Wide At The Joint & Has A Vertical Span Between Parallel Bows Of 25/8"

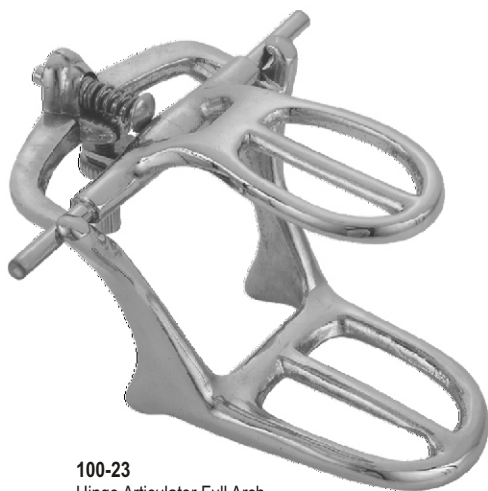

100-23
Hinge Articulator Full Arch Plaine Line Nickle Chromium Plated Articulator

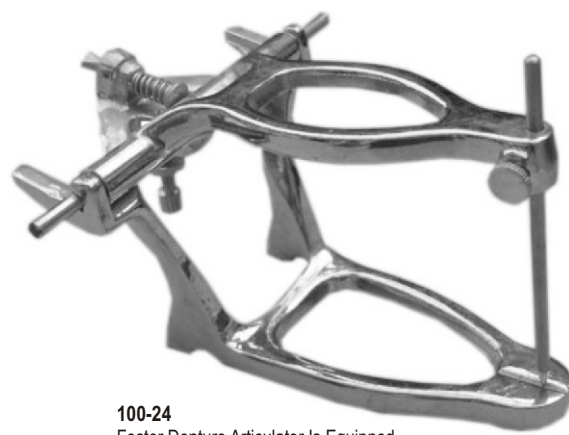

100-24
Foster Denture Articulator Is Equipped With An Adjustable Anterior Pin Stop & Posterior Screw Stop & Constructed Of A Slightly Heavier Gauge Brass Giving The Articulators A More Solid Feel

Dental Lab Instruments



200-001
Iwanson Spring Caliper
For Metal 0-10mm. Both
Side Graduation



200-002
Iwanson Spring Caliper
For Wax 0-10mm. Both
Side Graduation



200-003
Iwanson Spring Caliper
For Wax 0-10mm. Both
Side Graduation



200-004
Iwanson Spring Caliper
For Wax 0-10mm. Both
Side Graduation

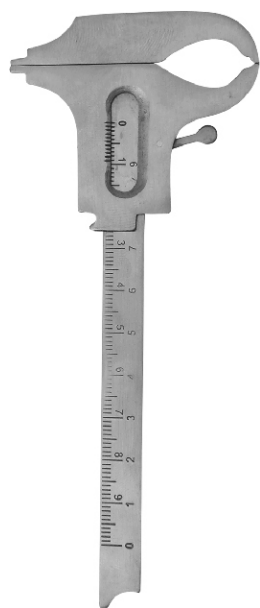

200-005
Orthodontic Boley
Decimal Caliper
Measuring Range
0-100 Mm



200-006
Orthodontic Boley
Decimal Caliper
Measuring Range
0-100 Mm



200-007
Orthodontic Boley
Decimal Caliper
Measuring Range
0-100 Mm

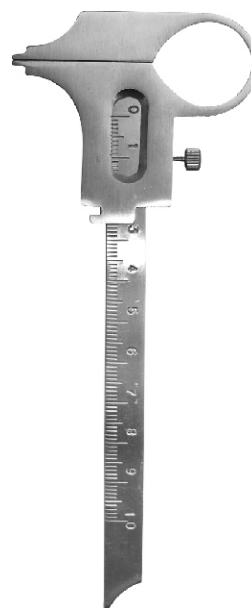

200-008
Orthodontic Boley
Decimal Caliper
Measuring Range
0-100 Mm

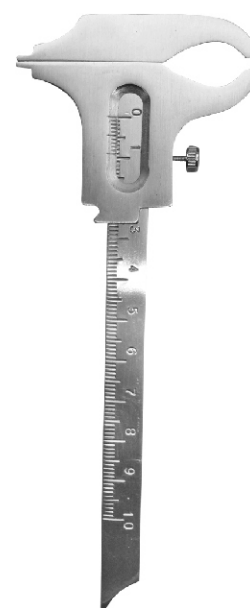

200-009
Orthodontic Boley
Decimal Caliper
Measuring Range
0-100 Mm

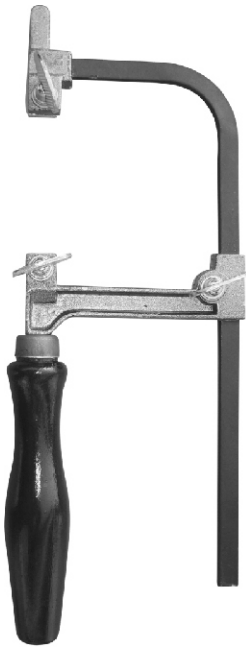

200-010
Fret Saws Frame
Cm.23 / 9" With
Adjustable Wooden
Hard Grip

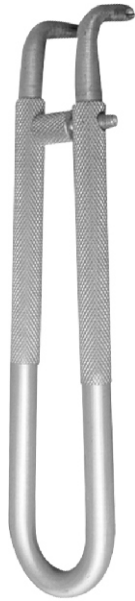

200-011
Lm-Cello Style
Stripholder Is The
Solution To Many
Clinical Problems



200-012
New Diamond
Strip Saw 10cm,
Stainless Steel



200-013
Standard Model
Saw For Sept-up
Available In Assorted
Colors



200-014
Smart Saw For
Models Cm.18
Available In
Assorted Colors



200-015
Jewelry & Watch
Caliper / Divider



200-016
Amalgam well
H.cm.4.0 Diam.
Cm. 3.50



200-017
Bone (Amalgam) Well
H.cm.3.5 Diam.cm.3.5



200-018
Amalgam well
H.cm. 2.00 Diam.
Cm. 3.00



200-019
Amalgam well knurled
H.cm. 3.00 Diam. Cm. 3.5



200-020
Non-Slip Bone (Amalgam)
Well



200-021
Non-Slip Bone (Amalgam)
Well

Dental, Ear & Veterinary Syringes



300-01
 Citoject Intraligamentary Syringe
 Syringe Injections Intra Ligaments,
 The Shape Pen & The Angled Tip
 Allows Easy Positioning Of The
 Needle. The Leverage Multiplier
 Offers Comfort For Injection Of The
 Health Practitioner. 10 Times Less
 Pressure And 10 Times Less Anesthetic
 Than Any Other Type Of Syringe



300-02
 Intraligamentary Syringe Deosy Type
 Intraligamentary Syringe
 (1.8ml, Inch Thread).
 Deosy Type Design,
 Without Undue Operator
 Fatigue. One Complete
 Squeeze Of The Trigger
 Releases One Dose(0.2cc)



300-03
 Intraligamentary Syringe - Pistol Style
 Autoclavable, Ergonomic Design,
 Accepts 1.8ml Carpules, Simple
 & Reliable Handling, Medical Grade
 Stainless Steel, One Trigger Lever
 Movement Corresponds To 0.2ml



300-04
 Intraligamentary Syringe - Pistol Style
 Autoclavable, Ergonomic Design,
 Accepts 1.8ml Carpules, Simple &
 Reliable Handling, Medical Grade
 Stainless Steel, One Trigger Lever
 Movement Corresponds To 0.2ml



300-05
 Skypject Intraligamentary Syringe Paroject
 (skypject) Syringe For Anesthesia,
 Intraligamentary With Packing. Used In
 Performing "pdl" Injections. Designed To
 Handle Any Standard Dental Cartridge &
 Uses Standard Disposable Dental Needles.
 Injects Only. 06ml Of Local Anesthetic With
 Each 'click' Of The Activator. Pen Style,
 Permanent Hub Design.



300-06
 Crutch Handle Cartridge
 Syringe Cartridge Syringe
 With Three Aspirating Hooks,
 Locking Device & Crutch
 Handle Folding Type
 (square Rod)

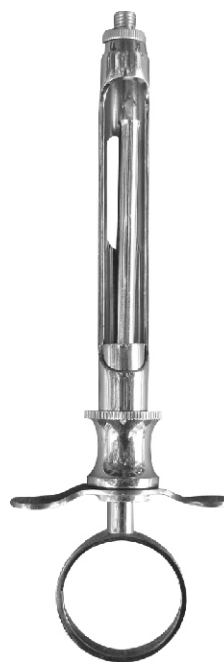

300-07
 Astra-Type (Cook-Waite)
 Aspirating Syringe With
 Arrow For Anesthesia
 With Metric / Us Thread.
 Non Folding - Chromium
 Plated Brass 1.8 Cc & 2.2 Cc



300-08
 Cartridge Syringe C-Type
 Cartridge Syringe Cylinder
 With Aspiration Metric/us
 Threads. Non Folding Type
 Chromium Plated Brass 1.8
 Cc & 2.2 Cc

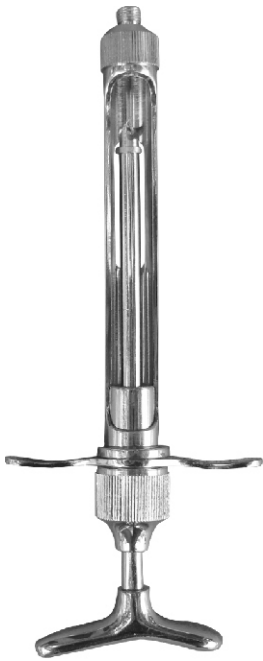

300-09
Flat Wing Non-Folding Type
Anesthesia Syringe
Cylinder Without Aspiration
Metric / Us Thread – 1.8 CC
& 2.2 CC

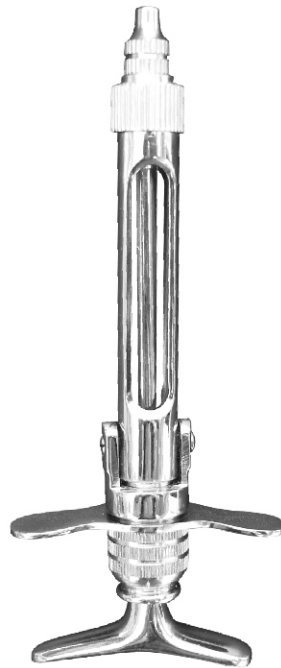

300-10
Flat Wing Folding Type
Anesthesia Syringe.
Cylinder Without Aspiration
Metric / Us Thread – 1.8 CC
& 2.2 CC



300-11
Flat Wing Cartridge Syringe
For Anesthesia, Folding Type.
Cylinder Without Aspiration
Metric / Us Thread. 1.8 CC
& 2.2 CC



300-12
Flat Wing Folding Type Anesthesia
Syringe. Cylinder Without Aspiration
Metric / Us Thread. Chromium Plated
Brass. 1.8 CC & 2.2 CC



300-13
3 Ring Cartridge Syringe For
Anesthesia - Non-Folding Type
Available In Us / Metric Threads



300-14
Articulated Syringe S-Type
Arpon Bayer For Anesthesia
- Non Folding - Chromium
Plated Brass. Available In
Us / Metric Threads



300-15
Aspirating Folding Cartridge
Syringe. Chromium Plated
Brass. 1.8 CC & 2.2 CC
Available in Us / Metric
Thread



300-16
Aspirating Folding Syringe
Strip Handle. Single side Folding
Type. Chromium Plated Brass.
1.8 CC & 2.2 CC. Available Us /
Metric Thread

Dental, Ear & Veterinary Syringes



300-17
 Aspirating Syringe Type-A (ASTRA) C-type cartridge syringe With aspiration, metric / us Threads. Non Folding. 1.8CC & 2.2 CC



300-18
 Pro Miltex "A" (ASTRA) Type Aspirating Syringe With Metric / Us Threads. Non Folding, Retract By Pulling Thumb Ring Back. Insert Cartridge, Plunger End First Into Barrel. Backward Motion Will Produce Aspiration. 1.8 CC & 2.2 CC



300-19
 Cork Screw Tip Aspirating Syringe For Anesthesia, Single Ring, Cylinder With Aspiration Metric/ Us Thread - Chromium Plated Brass. 1.8 CC & 2.2 CC



300-20
 Cork Screw Tip Aspirating Syringe For Anesthesia, Single Ring, Cylinder With Aspiration Metric/ Us Thread - Chromium Plated Brass. 1.8 CC & 2.2 CC



300-21
 Cartridge Syringe Cylinder With Aspiration, Metric/us Threads. Non Folding - Chromium Plated Brass 1.8 CC & 2.2 CC



300-22
 Cook-waite Type Self Aspirating Syringe, 1.8 CC & 2.2 C For Anesthesia, Light Weight Construction Of Aluminum & Stainless-steel. Available In Us / Metric Threads & Assorted Colors Handles



300-23
 Self Aspirating Aspiject Syringe With Saddle Grip, For Anesthesia Stainless Steel & High Tech Polymer Construction Which Allows It To Be Completely Sterilizable

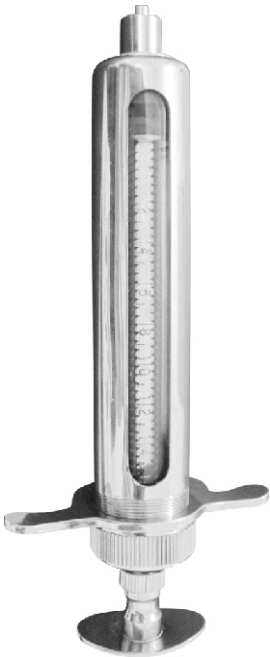

300-24
Veterinary Metal Syringe
Made Of Copper & Finished By
Chromium Plating. High Quality
That It Will Stand The Test Of Time.
Designed For One Hand Operation
& Are Easy To Disassemble & Clean.
Disinfect It In Boiled Water. 10ml 20ml
30ml 50ml Is Available



300-25
Detail: Components From (i To V)
Are Made Of Copper & Finished By
Chromium Plating **Functions:** Mainly
Used For Animal Disease Prevention
& Treatment By Vet **Note:** The Disinfection
In Boiled Water Is Applicable ForSyringes.
High-pressure Steam Disinfection Is
Prohibited



300-26
Veterinary Pistol Grip Pro-Shot
Syringes Europlex Metal Gun
Syringe / Pro-shot 50cc Is Ruggedly
Built From Highimpact Plastic To Be
Both Durable. Transparent, Graduated
Barrel. Which Will Not Discolor. Simple
Dosage Sleeve Can Be Easily Adjusted
From 1 To 5 Ccs. Non-adjustable Nylon
Plunger Assembly & A Luer Lock Hub.
Extremely Accurate Pro-shot 5cc Pistol-
grip Syringe Combines Outstanding Features



300-27
Veterinary Syringe C-Type
A Durable Plastic Syringe That
Will Stand The Test Of Time.
Clear Plastic Barrel, Black Inscribed
Graduations & Orange Handles.
Syringes Have Luer-Lock Luer-Slip
Needle Holder & Are Autoclavable
Up-to 150° Available In 10ml, 20ml,
30ml, 50ml & 100ml



300-28
Reiner Ear Syringe With
3 Cannulas & 1 Protecting
Disk. Available In 50ml,
75ml, 100ml & 150ml



300-29
Aqua-fix Irrigating Self Filling
Water Syringe (all Metal) For Ear.



300-30
Ear Syringe With Spring.
Chrome Plated

Crown Removers



100-224
Morrel Crown Removers
(Manual) Double Ended
With 2 Tips



100-225-A
Crown Remover Fully
Automatic With 3 Attachments



100-225
Crown Remover Butler Fully
Automatic With 3 Attachments.
Three Spring Action Impact Levels
With Manual Cock. Nickle Chromium
Plated Brass



100-226
Morrel Crown Remover (manual)
Single Ended With 5 Attachments,
Spring. Stainless Steel



100-227
Crown Remover Fully Automatic
With 3 Attachments, Lock & Key.
Adjustable Spring Action Impact
With Automatic Cock. Stainless Steel



100-228
Morrel Crown Remover
(manual) Double Ended
With 5 Attachments.
Stainless Steel



100-229
Morrel Crown Remover
(manual) Double Ended
With 3 Attachments.
Stainless Steel

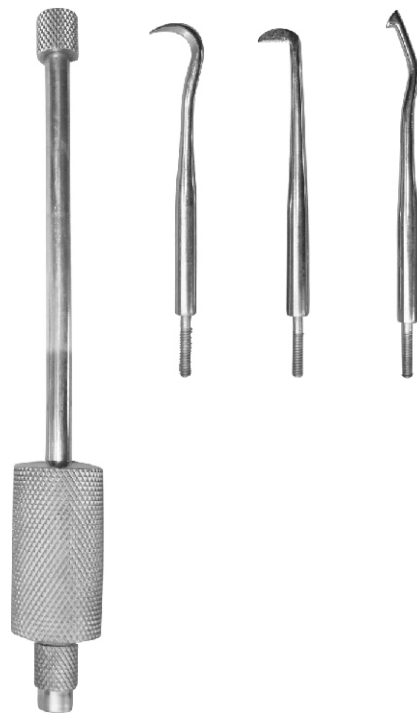

100-230
Morrel Crown Remover
(manual) Double Ended
With 3 Attachments.
Stainless Steel

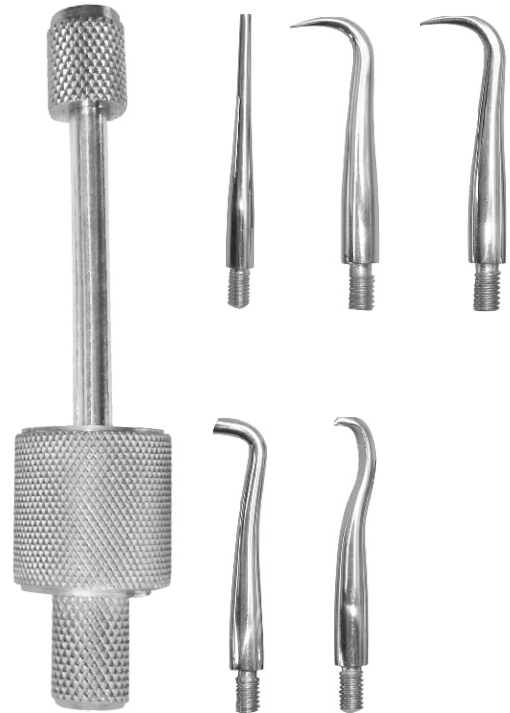

100-231
Morrel Crown Remover
(manual) Double Ended
With 5 Attachments.
Stainless Steel



SECTION #02

Handle Options:
 Extracting Forceps English Pattern:
 Extracting Forceps Mead Pattern:
 Wisdom Teeth Extracting Forceps:
 Extracting Forceps Children:

Page 13
 Page 14 to 21
 Page 22
 Page 23
 Page 24 to 26

Extracting Forceps American Pattern: Page 27 to 31
 Extraction Tweezer: Page 32

Handle Options

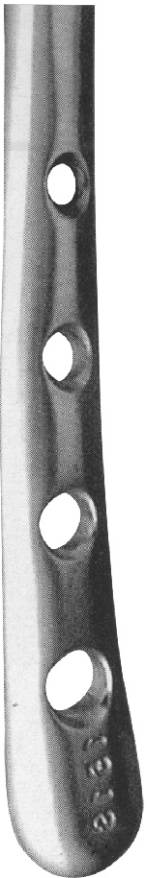

200-01
 Extraction forceps With
 Friction grip and Extra
 Light Handle

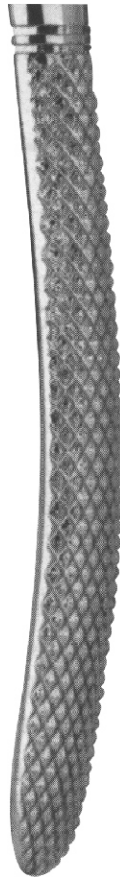

200-02
 Extraction forceps With
 Friction grip and Serrated
 Handle

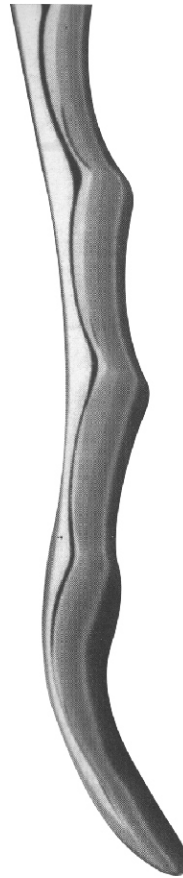

200-03
 Extraction forceps With
 Friction grip and Anatomically
 Shaped Handle

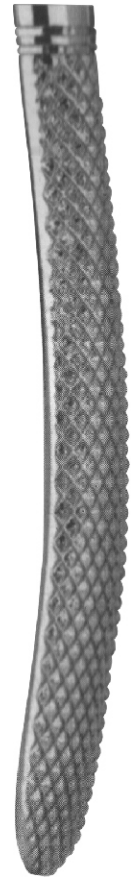

200-04
 Extraction forceps Medium Size
 With Special Grip-Power-Tips,
 Serrated Handle and Golden
 Finished Handle-Tips

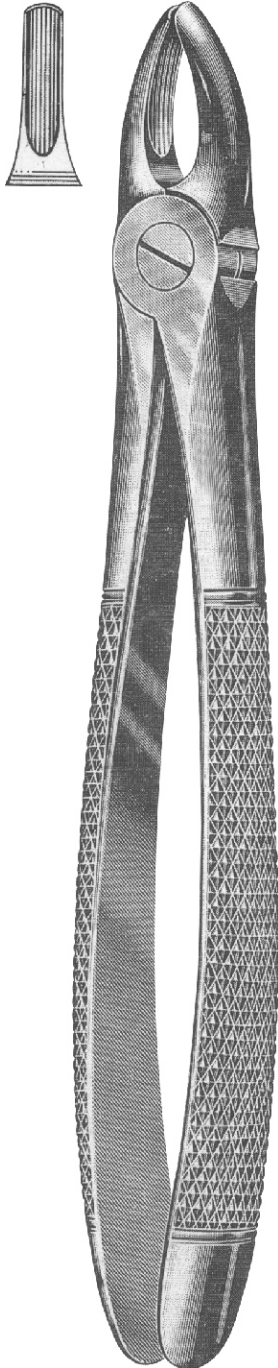

200-05
Fig. 1
Upper Centrals
& Canines

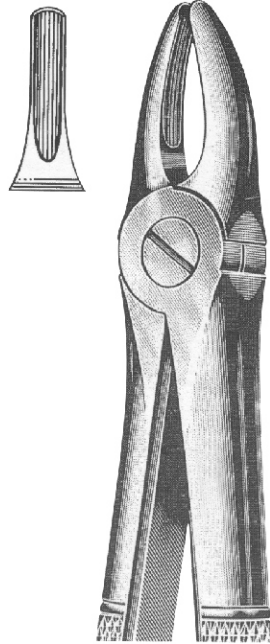

200-06
Fig. 2
Upper Laterals
& Bicuspids

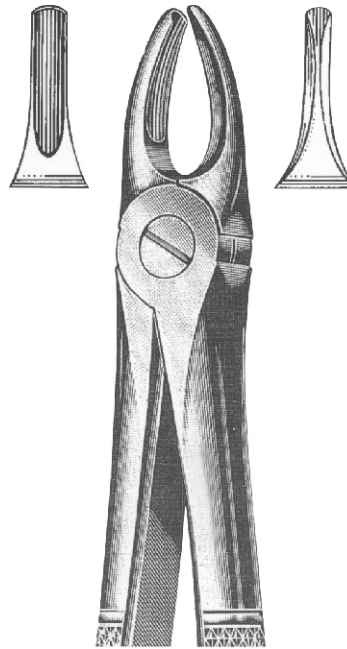

200-07
Fig. 3
Upper Incisors
& Canines

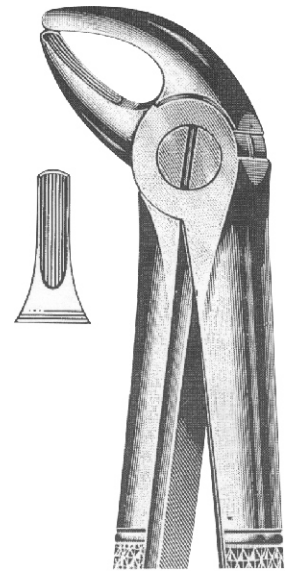

200-08
Fig. 4
Lower Incisors
& Canines

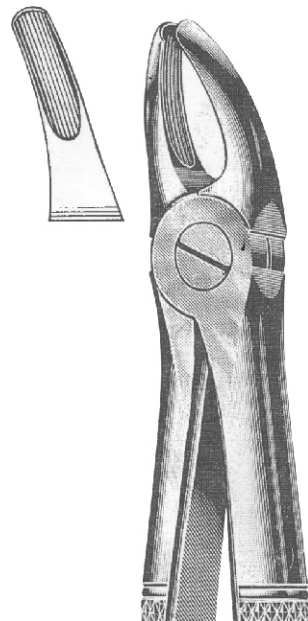

200-09
Fig. 7
Upper Primolars

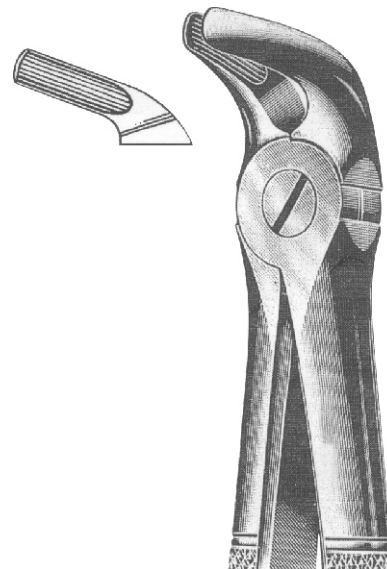

200-10
Fig. 8
Lower Primolars

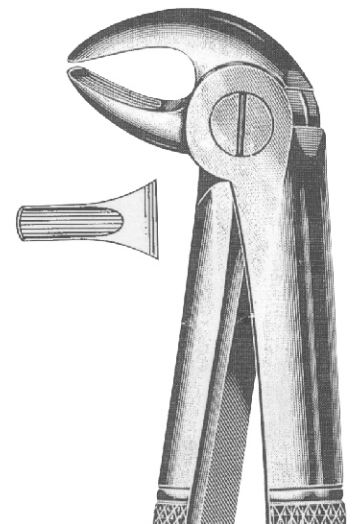

200-11
Fig. 13
Lower Primolars

Extracting Forceps English Pattern

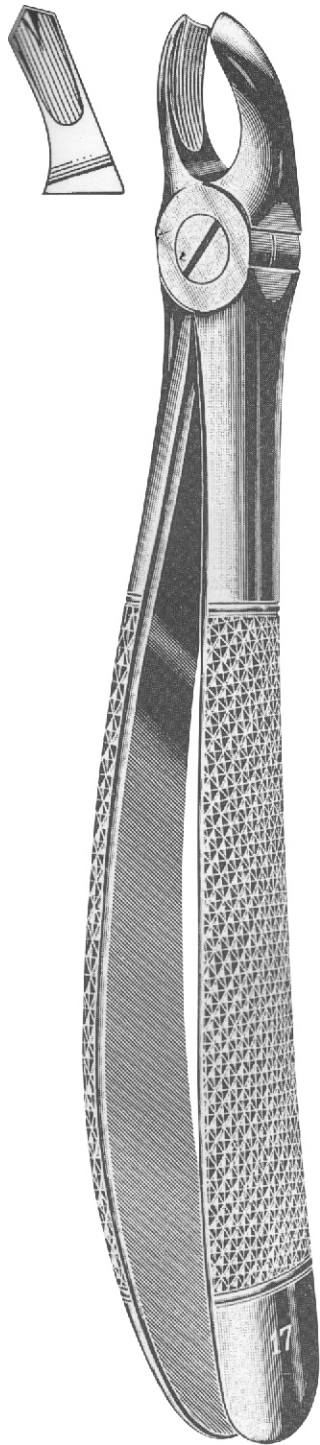

200-12
Fig. 17
Right Upper molars

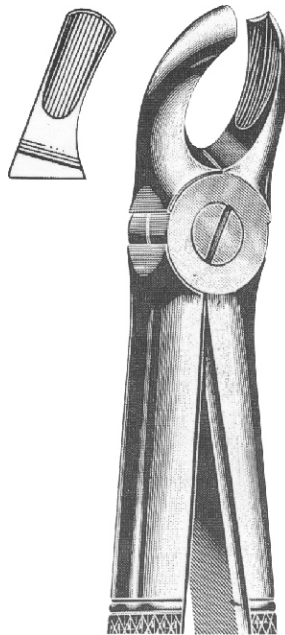

200-13
Fig. 18
Left Upper molars

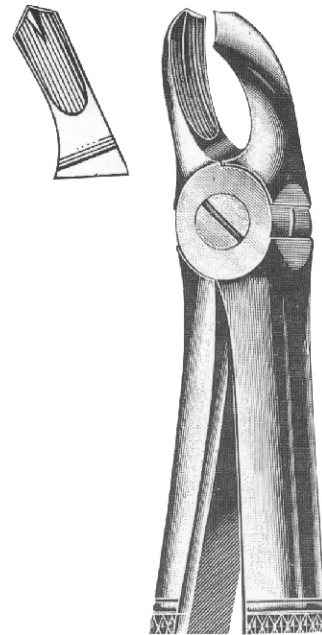

200-14
Fig. 18A
Upper molars

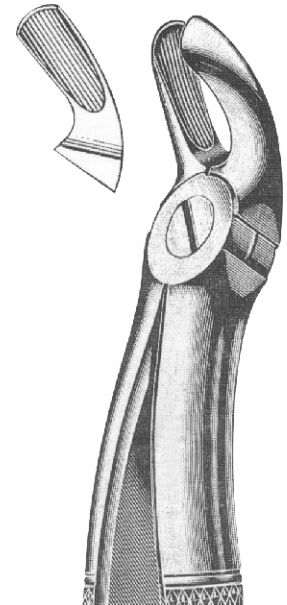

200-15
Fig. 19
Upper Wisdoms

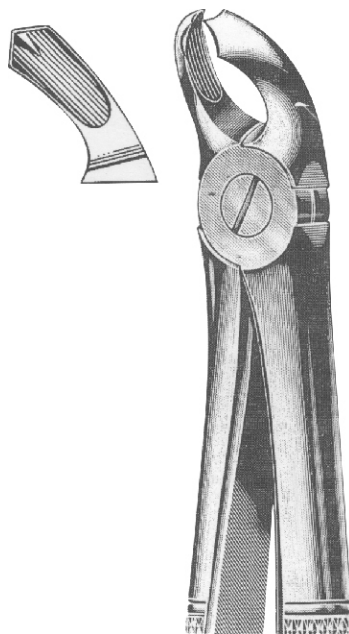

200-16
Fig. 20
Lower Wisdoms

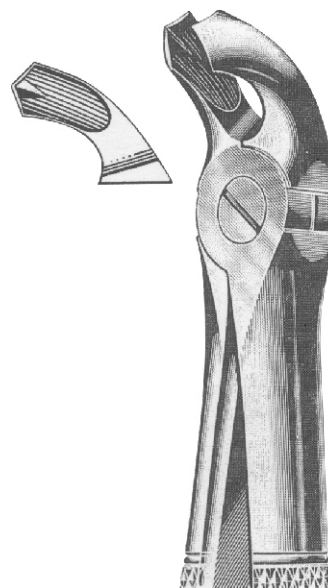

200-17
Fig. 21
Lower Molars

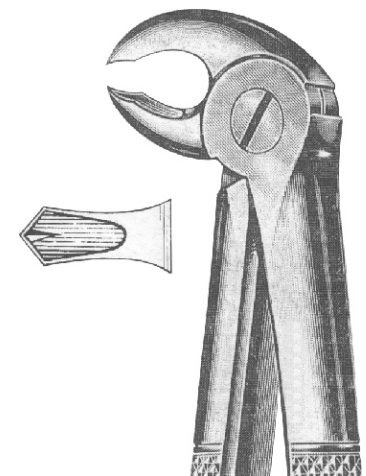

200-18
Fig. 22
Lower Molars
Hawk's Bill

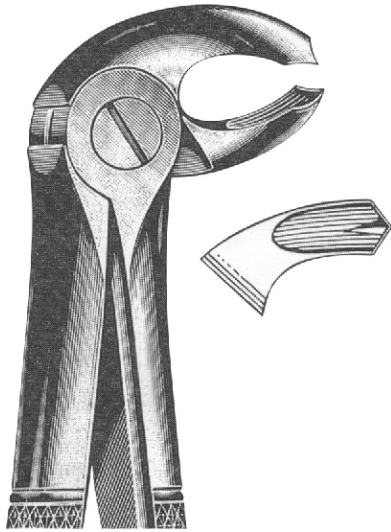

200-19
Fig. 23
Right Lower Molars

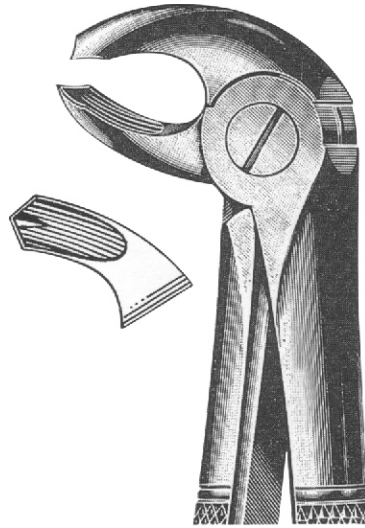

200-20
Fig. 24
Left Lower Molars

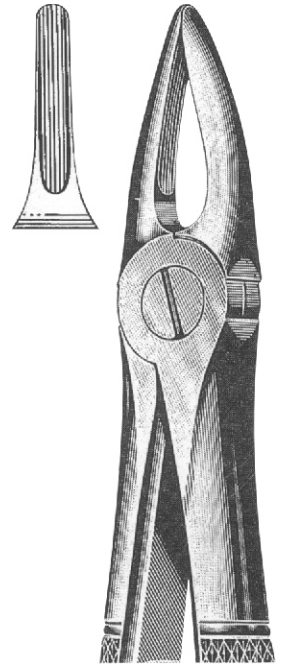

200-21
Fig. 29
upper Roots
& Incisors

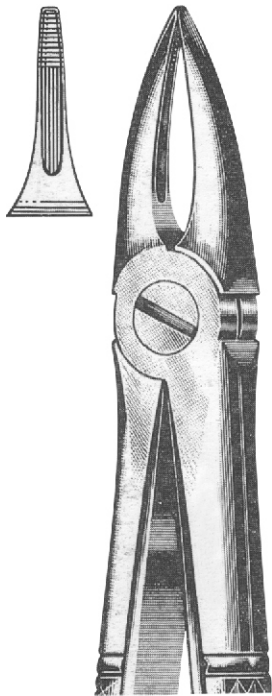

200-22
Fig. 29N
Roots Of Upper
Incisors

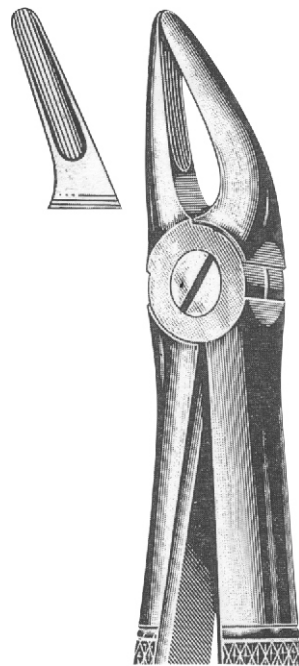

200-23
Fig. 30
Upper Roots
& Incisors

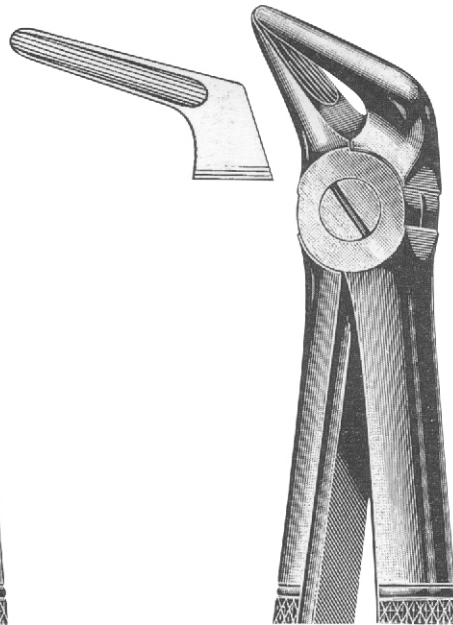

200-24
Fig. 31
Lower Roots

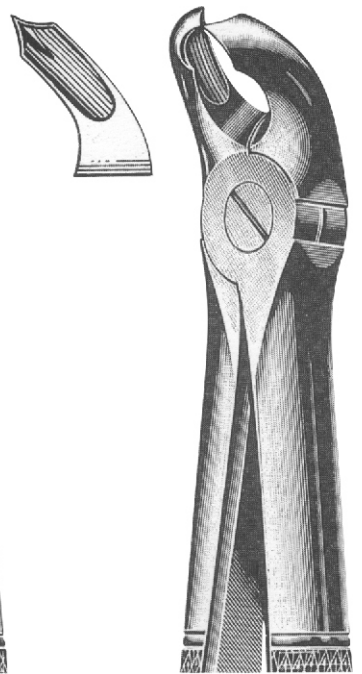

200-25
Fig. 32
Lower Molars

Extracting Forceps English Pattern

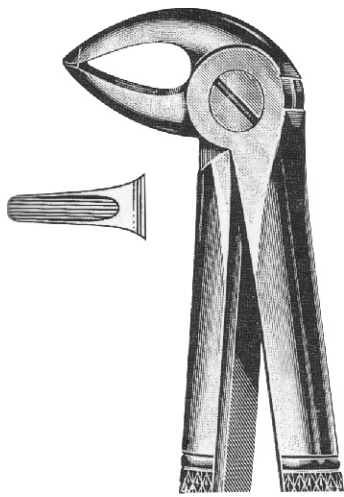

200-26
Fig. 33
Lower Roots

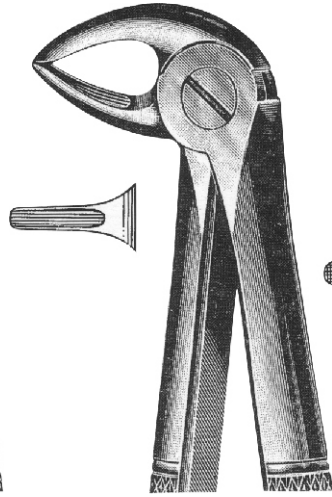

200-27
Fig. 33A
Lower Roots

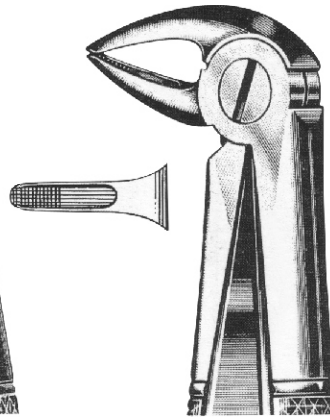

200-28
Fig. 33C
Lower Roots

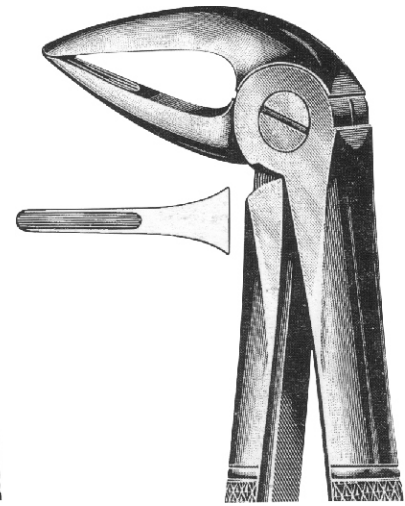

200-29
Fig. 33M
Lower Roots
With Logn Beak

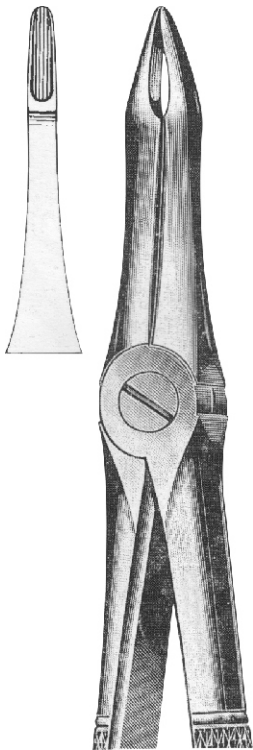

200-30
Fig. 41
Upper Roots

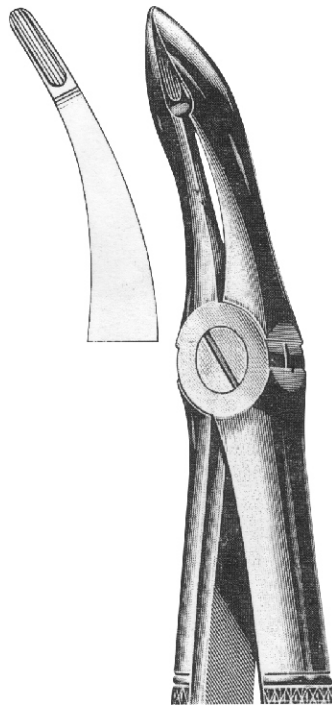

200-31
Fig. 44
Upper Roots

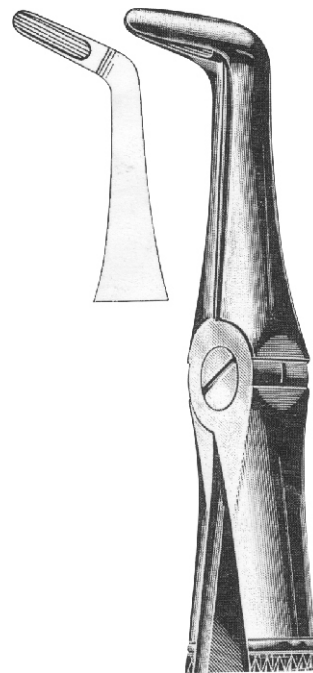

200-32
Fig. 45
Lower Roots

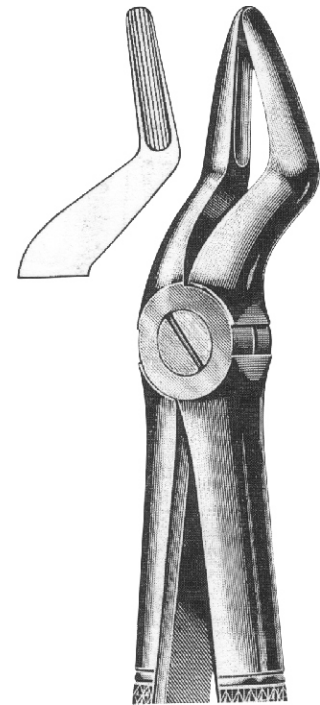

200-33
Fig. 51
Upper Roots

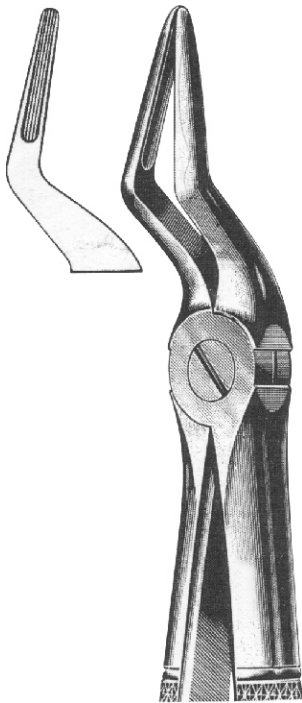

200-34
Fig. 51A
Upper Roots
Narrow Beak

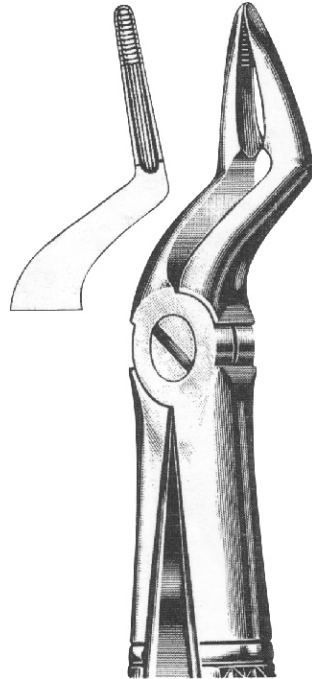

200-35
Fig. 51C
Upper Roots

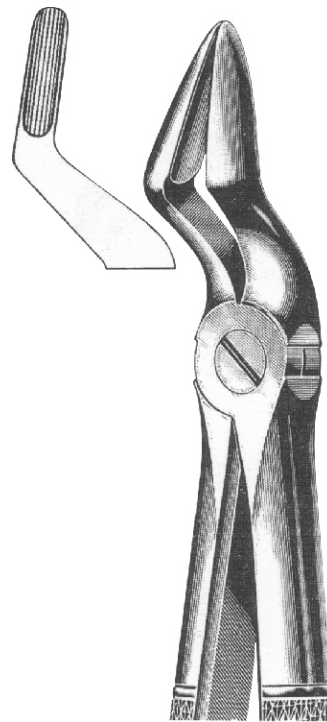

200-36
Fig. 52
Upper Roots & Canines
With Wider Beak

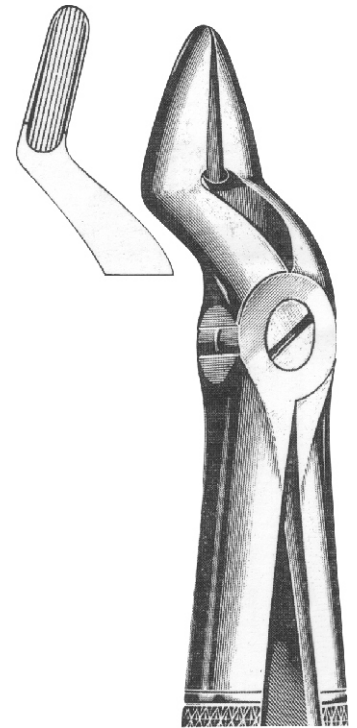

200-37
Fig. 52A
Upper Teeth
& Resction

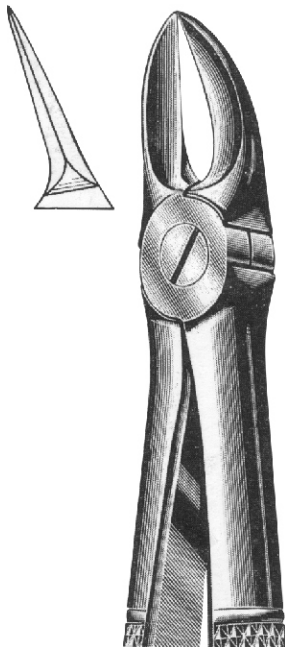

200-38
Fig. 55
Separating Upper
molars Roots

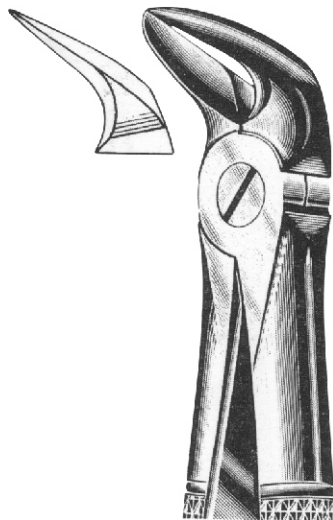

200-39
Fig. 56
Separating Lower
molars Roots

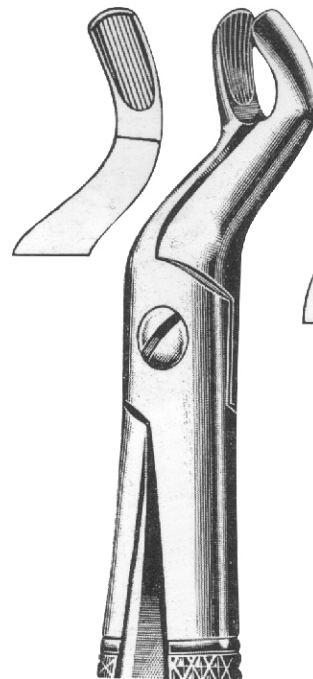

200-40
Fig. 67
Upper Wisdoms

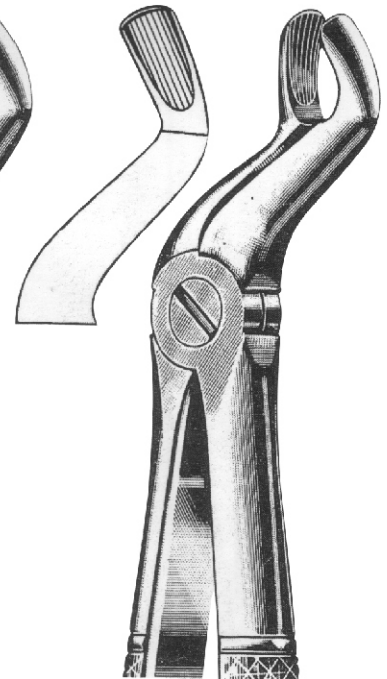

200-41
Fig. 67A
Upper Wisdoms

Extracting Forceps English Pattern

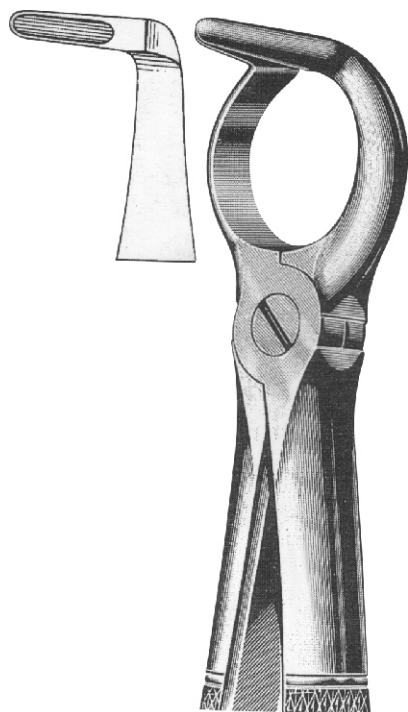

200-42
Fig. 68
Lower Roots

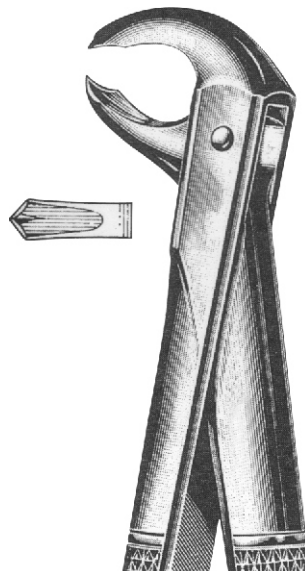

200-43
Fig. 73
Lower Molars
(Hawk's Bill)

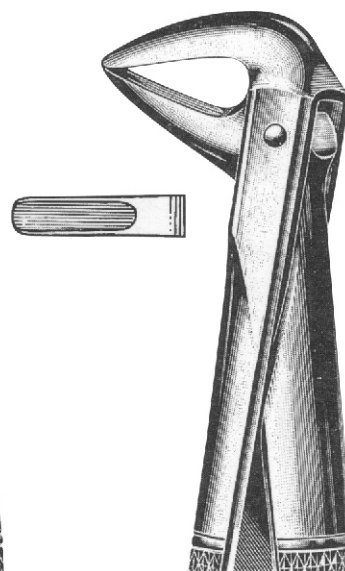

200-44
Fig. 74
Lower Incisors
& Roots

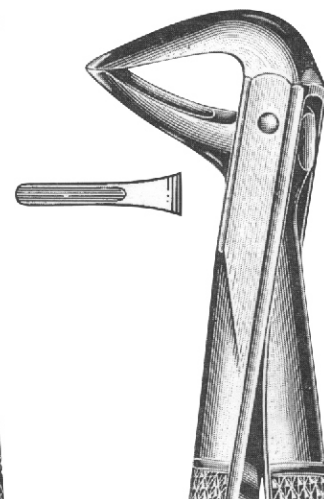

200-45
Fig. 74M
Lower Incisors
& Roots

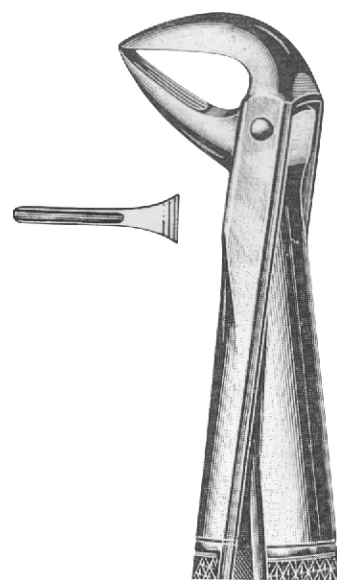

200-46
Fig. 74N
Lower Incisors
& Roots

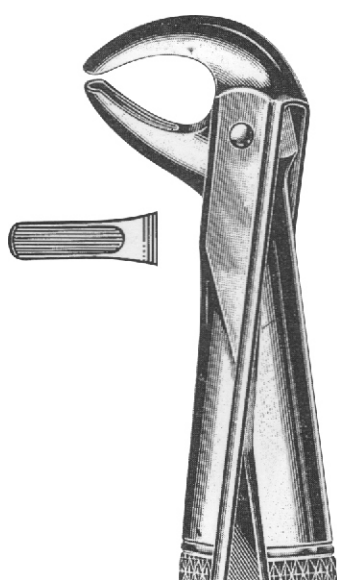

200-47
Fig. 75
Lower Premolars
& Canines

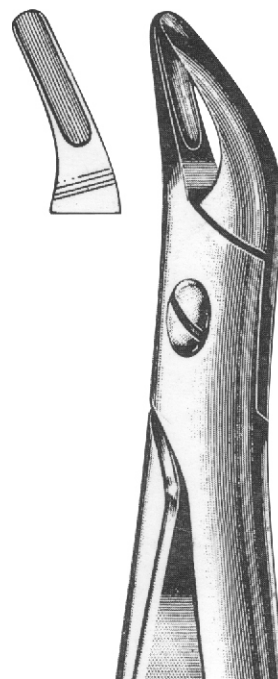

200-48
Fig. 76
Upper Roots

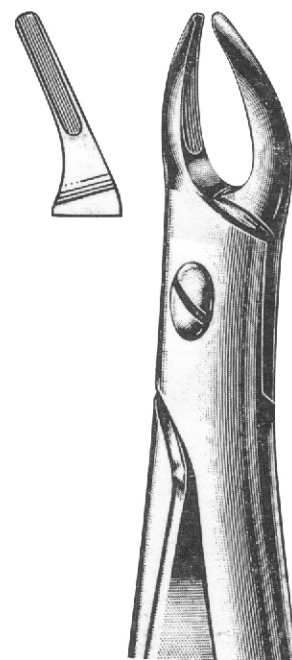

200-49
Fig. 76N
Upper Roots
(Narrow Beak)

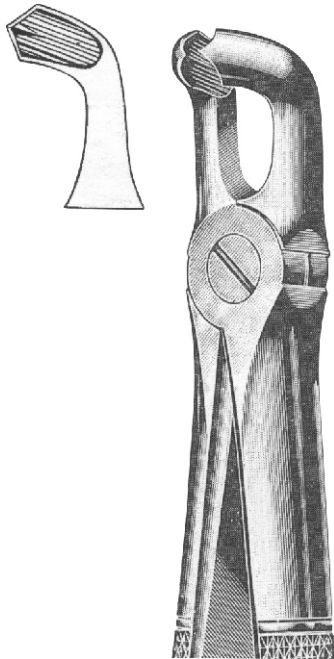

200-50
Fig. 79
Lower Wisdoms

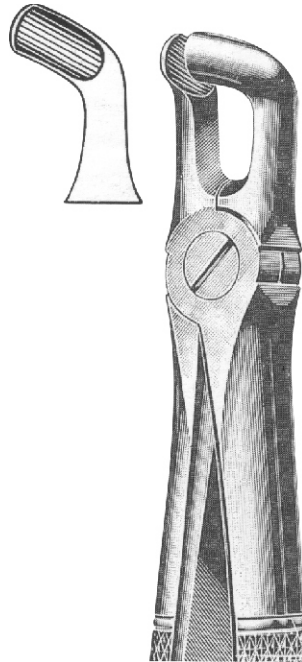

200-51
Fig. 79A
Lower Wisdoms

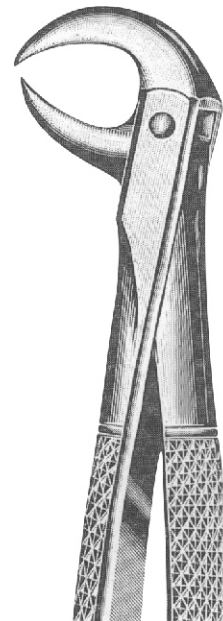

200-52
Fig. 86A
Lower Molars

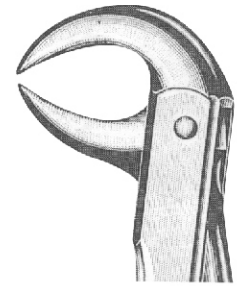

200-53
Fig. 86B
Lower Molars

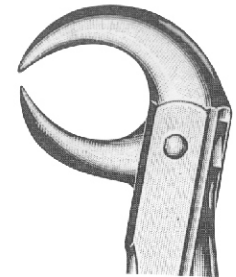

200-54
Fig. 86C
Lower Molars

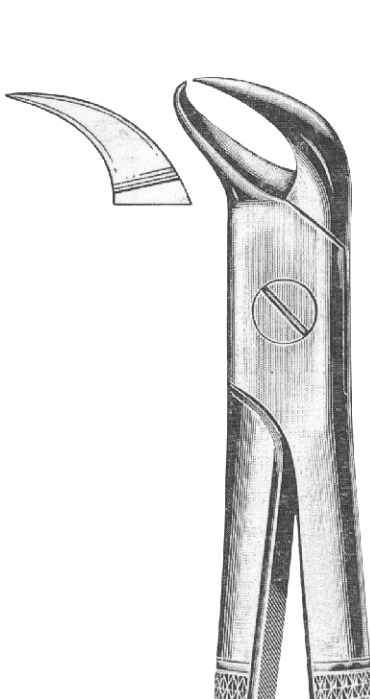

200-55
Fig. 87
Cownhorn Beak

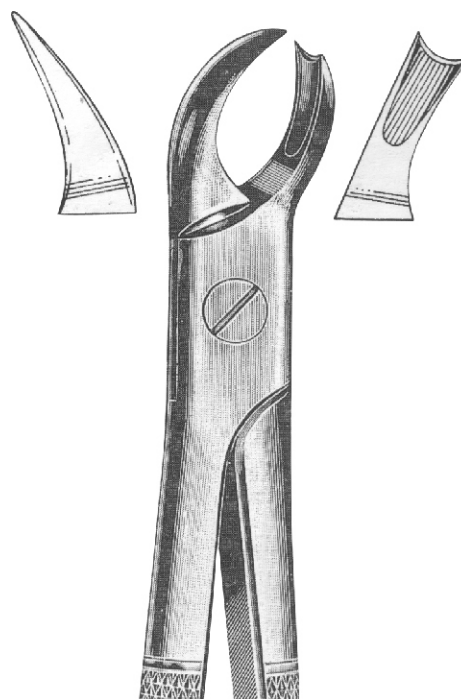

200-56
Fig. 89
Right Upper molars

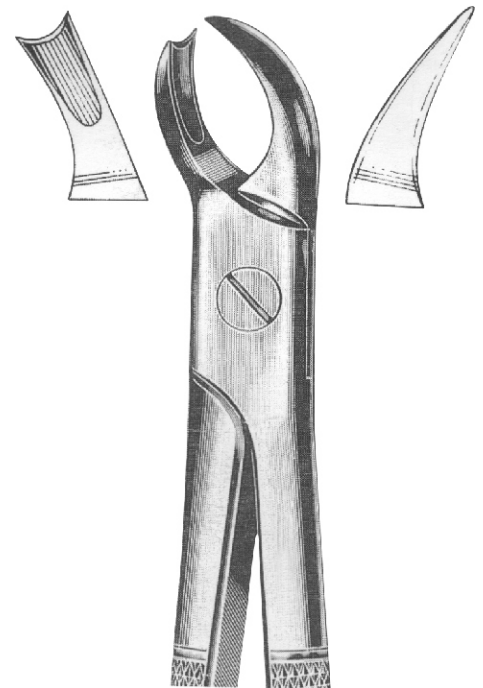

200-57
Fig. 90
Left Upper molars

Extracting Forceps English Pattern

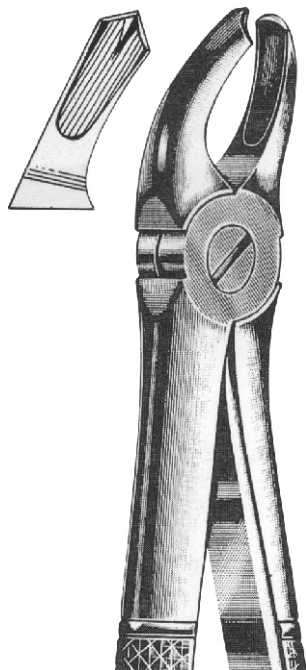

200-58
Fig. 94
Right Upper molars

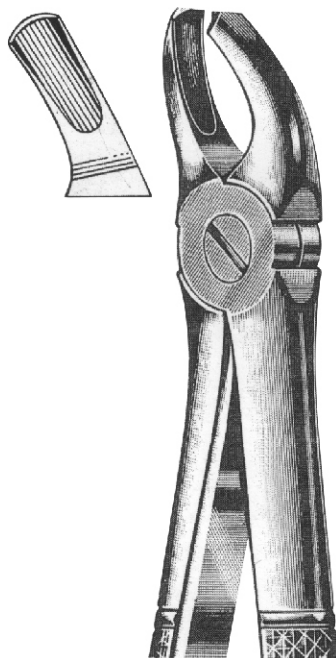

200-59
Fig. 95
Left Upper molars

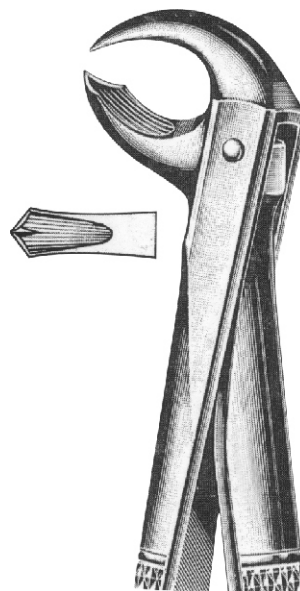

200-60
Fig. 99
Lower molars
(Broken-Down)

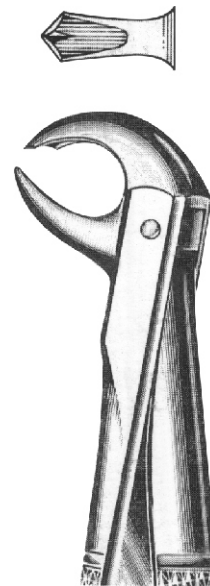

200-61
Fig. 99 1/4
Lower molars
(Broken-Down)

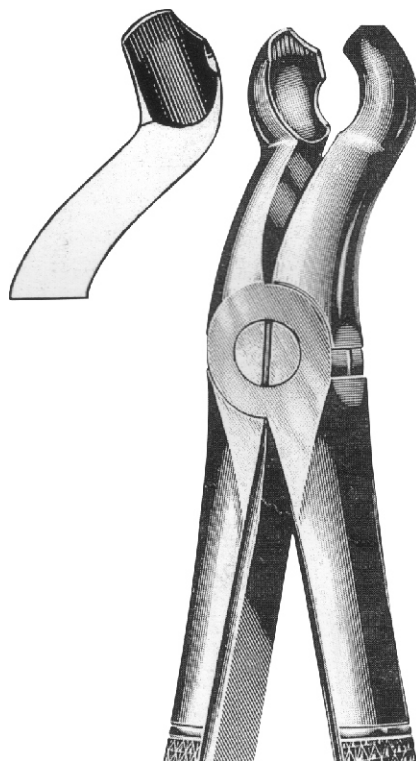

200-62
Fig. 121
Upper Wisdoms

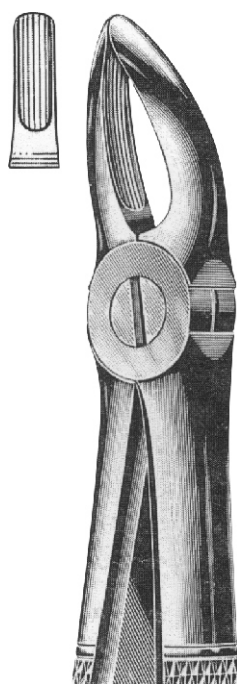

200-63
Fig. 136
Upper Centrals
& Roots

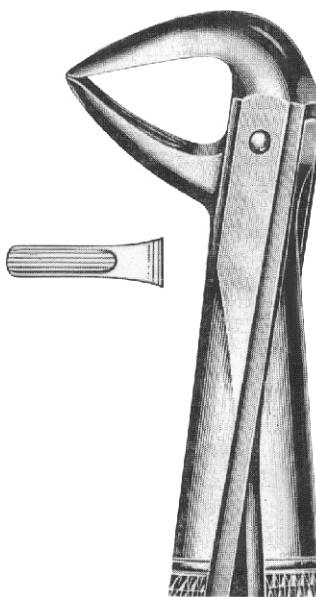

200-64
Fig. 137
Lower Centrals
& Roots

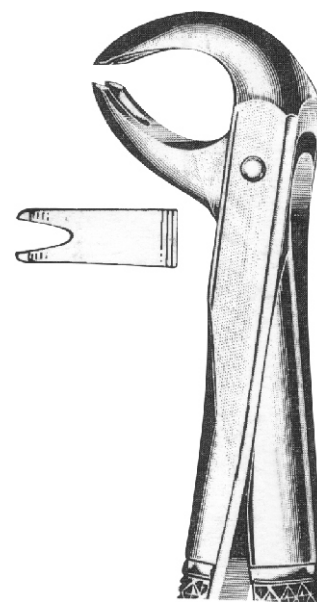

200-65
Fig. 167
Universal Pincer
For Lower Teeth
Molars & Premolars

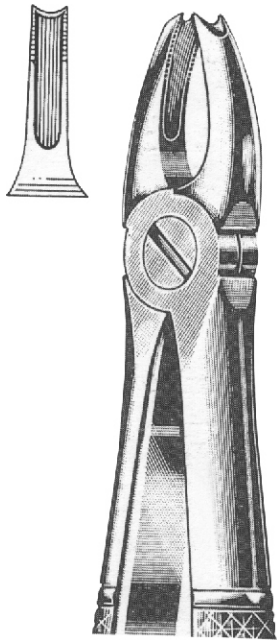

200-66
Fig. 168
Upper Canines

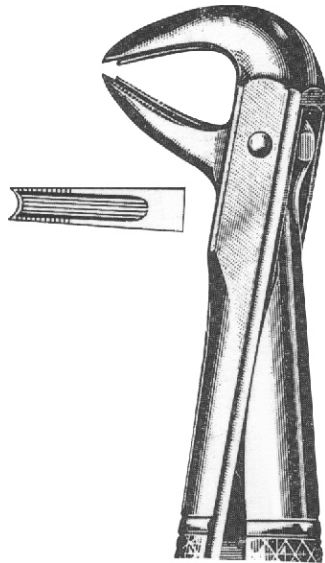

200-67
Fig. 169
Lower Canines
& Premolars

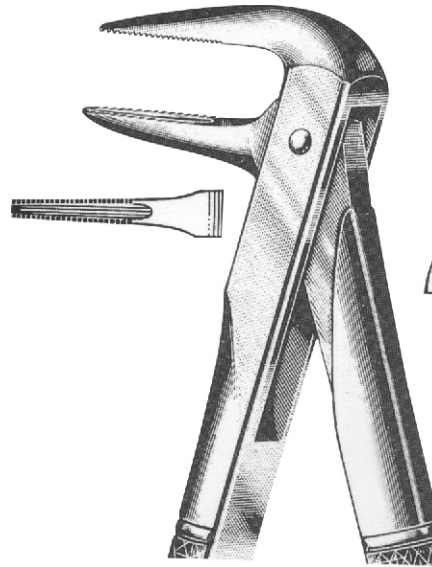

200-68
Fig. 233
Lower Roots
(parallel Beaks)

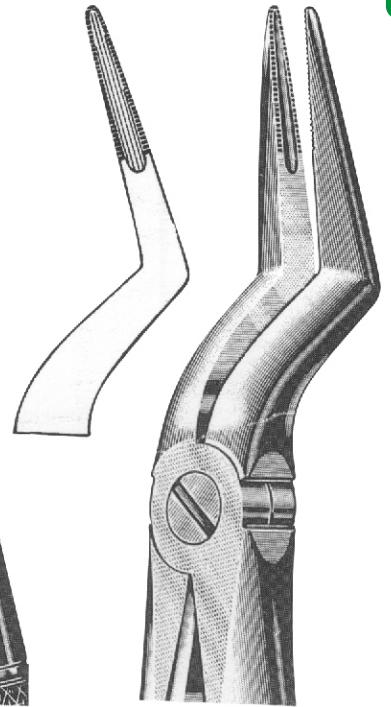

200-69
Fig. 235
Upper Roots
(parallel Beaks)

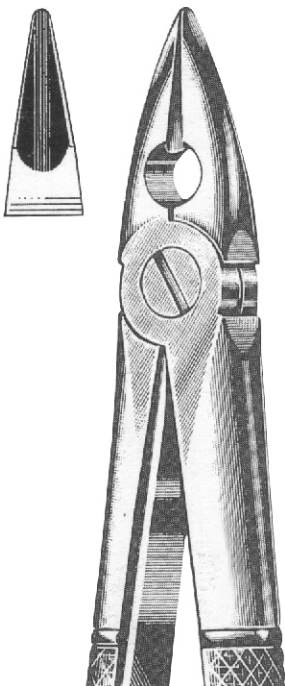

200-70
Fig. MD 1
Universal Forceps For Upper
Wisdoms, Premolars & Roots

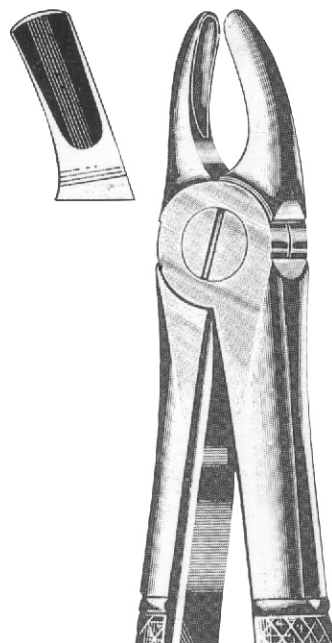

200-71
Fig. MD 2
Upper Molars

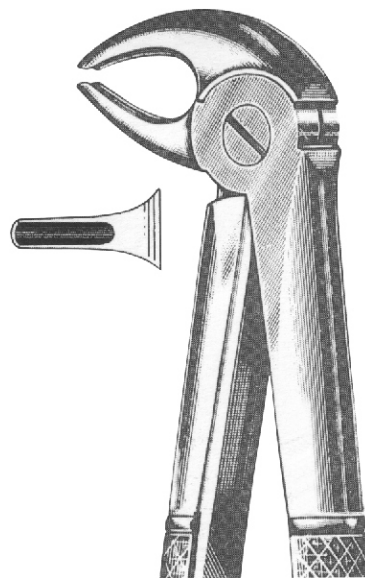

200-72
Fig. MD 3
Lower Incisors, Premolars
& Roots

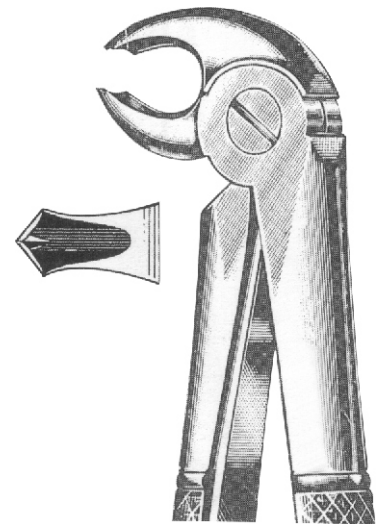

200-73
Fig. MD 4
Lower Molars

Wisdom Teeth Extracting Forceps

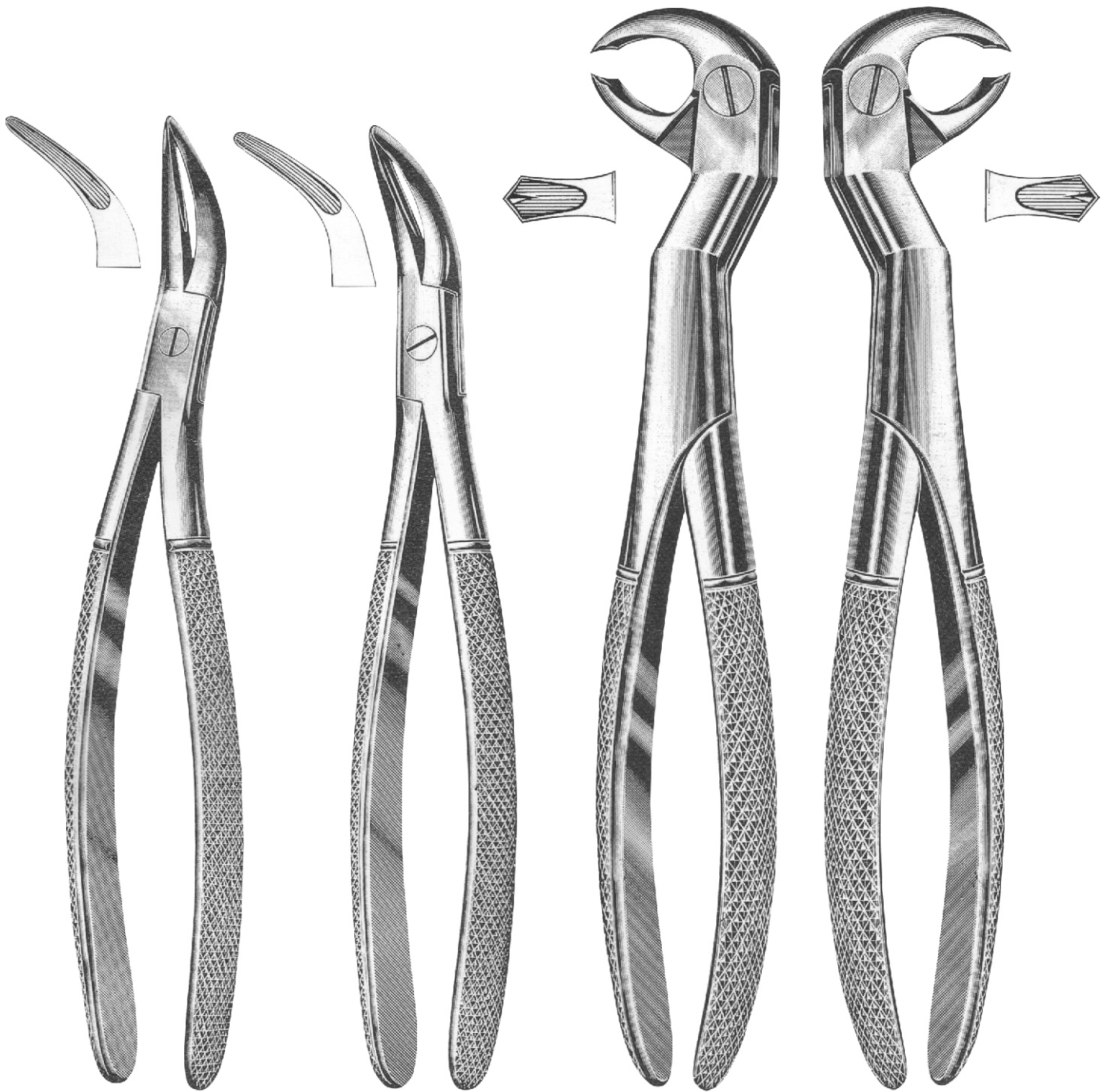

200-74
Universal Pattern For
Upper Teeth

200-75
Universal Pattern For
Lower Teeth

200-76
Fig. 22 1/2L
Left Lower Wisdoms
& Molars

200-77
Fig. 22 1/2R
Right Lower Wisdoms
& Molars

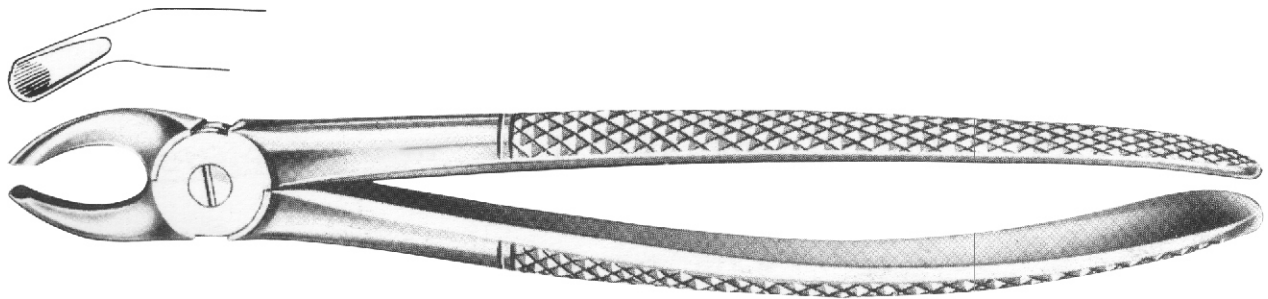

200-78
Fig. 158
Children's Upper Molars Universal

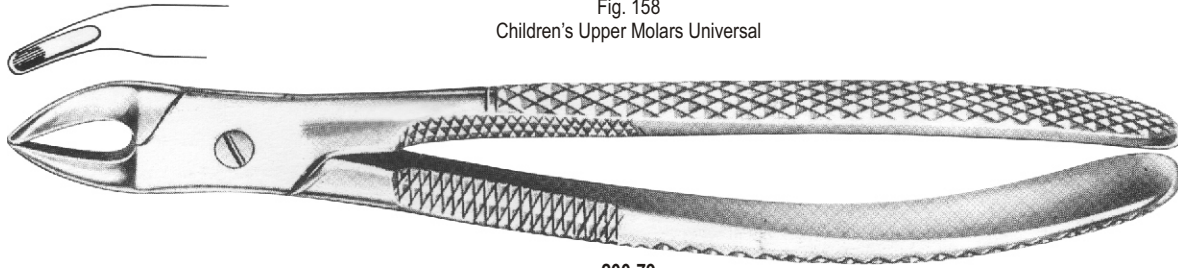

200-79
Fig. 159
Children's Upper Teeth Universal

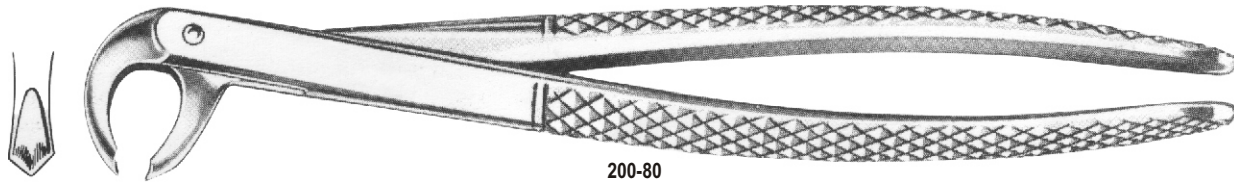

200-80
Fig. 160
Children's Lower Molars Universal (Hawk's Bill)

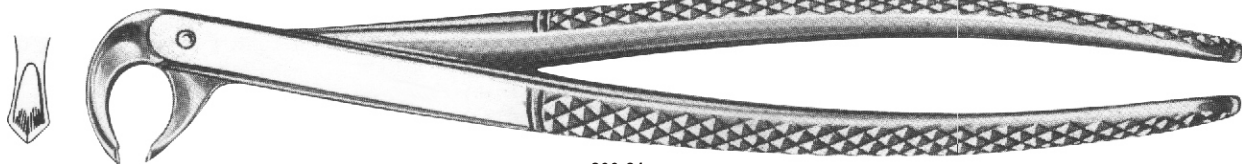

200-81
Fig. 161
Children's Lower Centrals & Roots

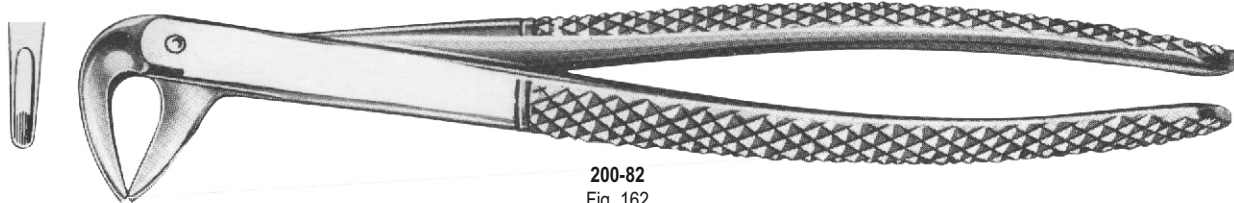

200-82
Fig. 162
Children's Upper Centrals

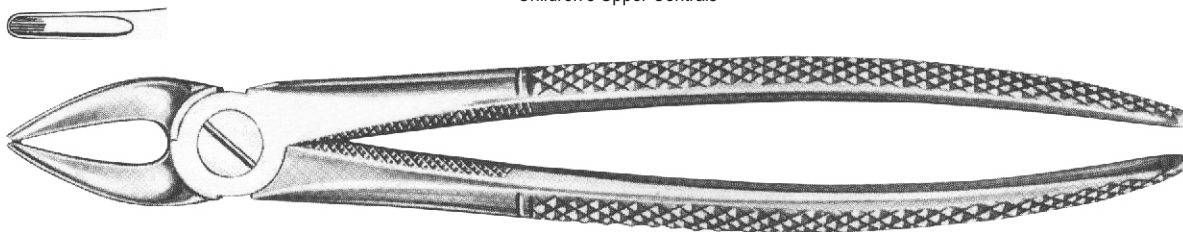

200-83
Fig. 163
Children's Upper Centrals

Extracting Forceps Children's Pattern

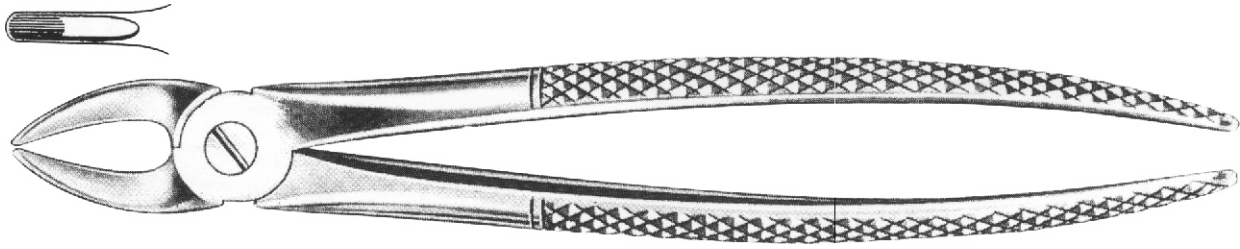

200-84

Fig. 37

Children's Upper Incisors & Canines

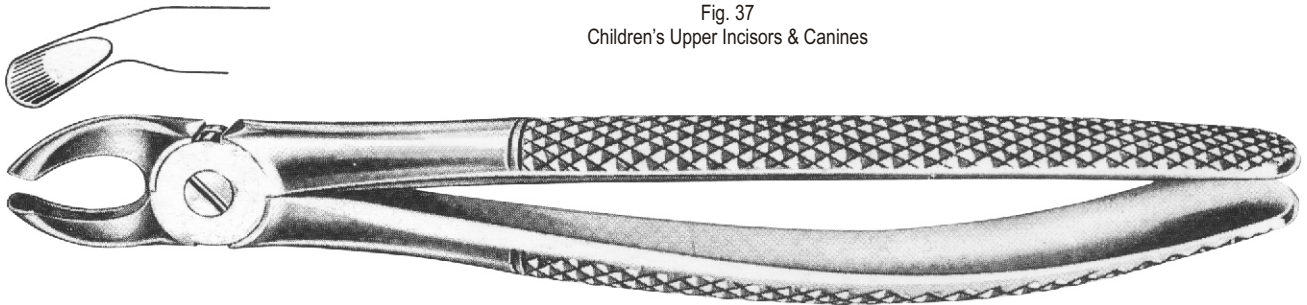

200-85

Fig. 39

Children's Upper Molars Universal

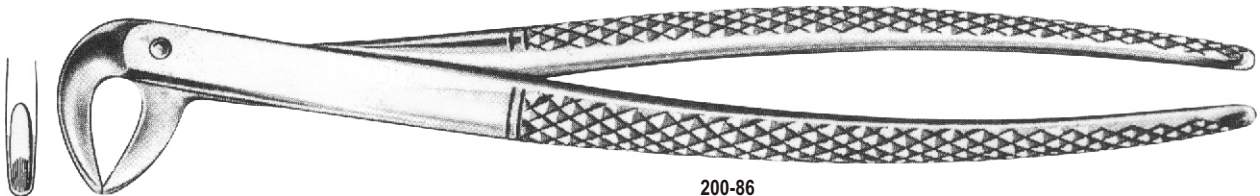

200-86

Fig. 123

Children's Lower Teeth Universal

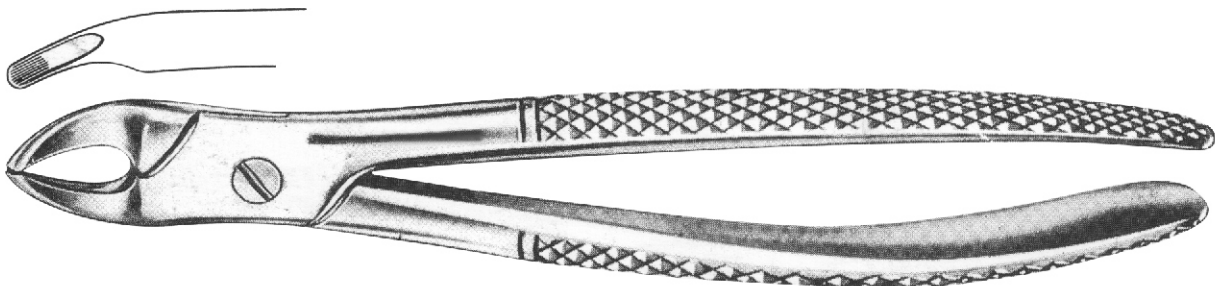

200-87

Fig. 138

Children's Upper Universal & Roots

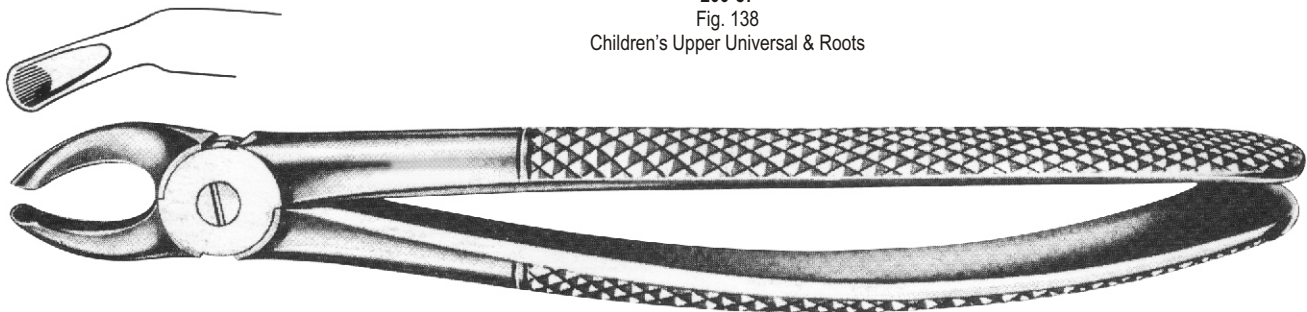

200-88

Fig. 157

Children's Upper Molars Universal

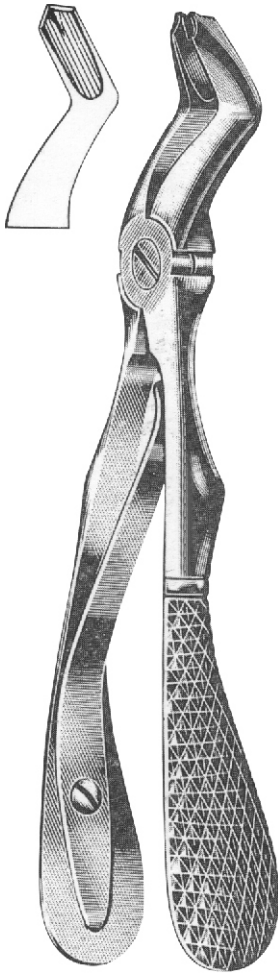

200-89
Fig. 3
Upper Molars

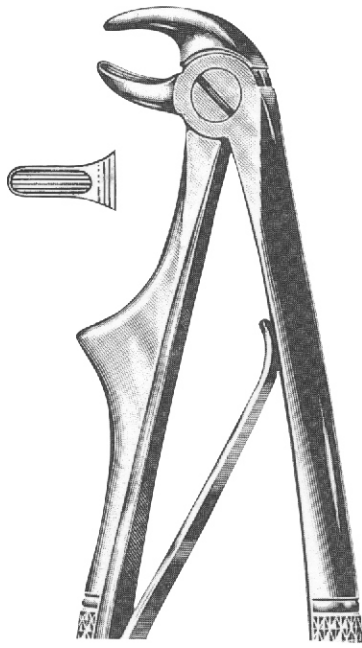

200-90
Fig. 5
Lower Incisors

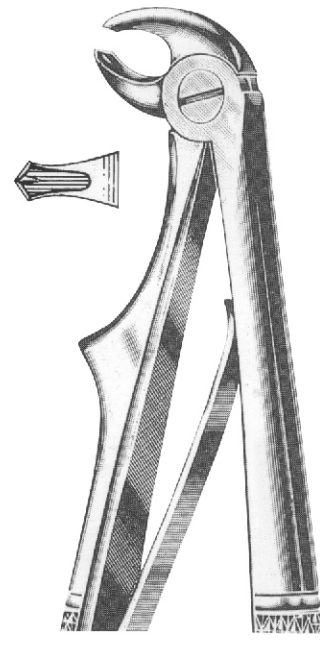

200-91
Fig. 5
Lower Molars

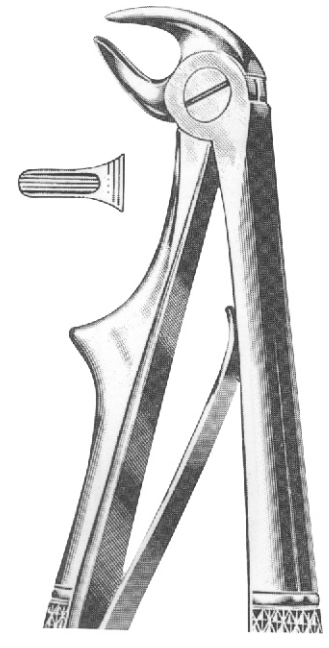

200-92
Fig. 7
Lower Roots

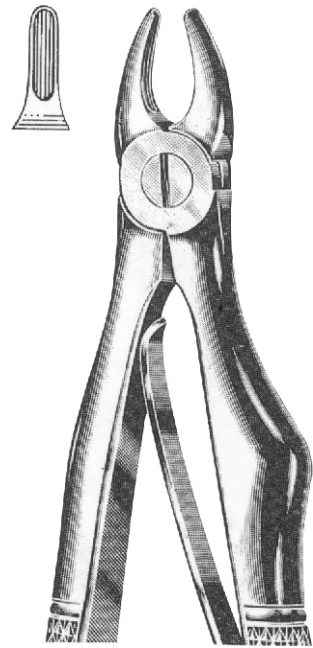

200-93
Fig. 137
Upper Incisors
& Canines

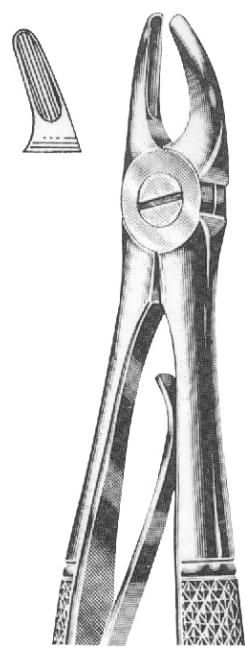

200-94
Fig. 139
Upper Premolars

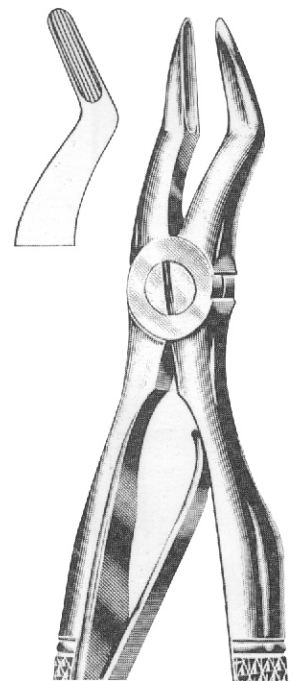

200-95
Fig. 51S
Upper Roots

Extracting Forceps American Pattern

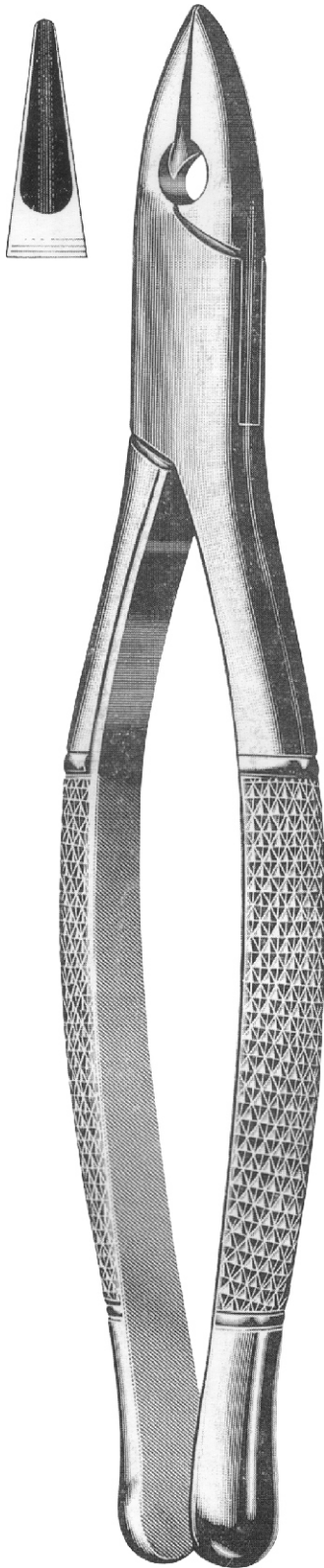

200-96
Fig. 1
Upper Centrals, Laterals
& Cuspids

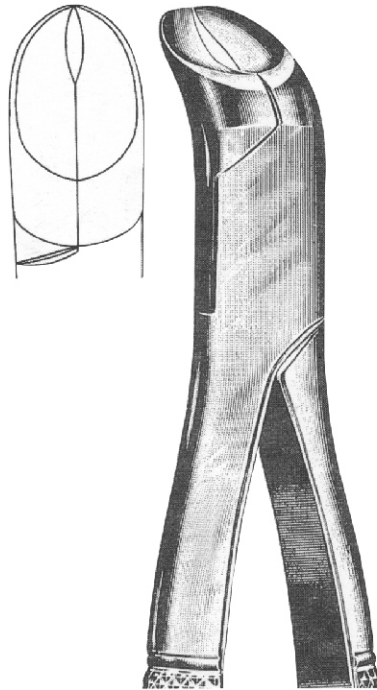

200-97
Fig. 5
Lower Third Molars

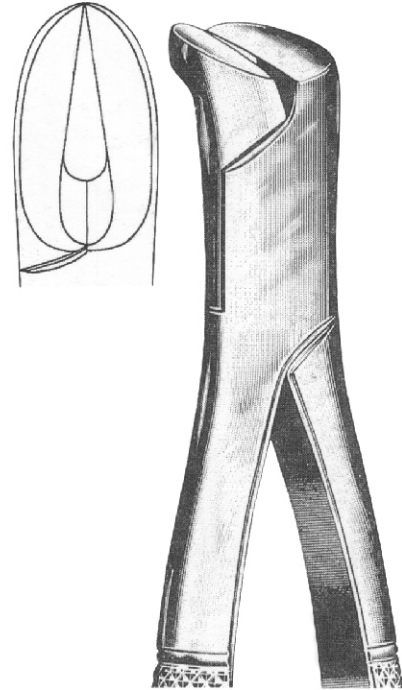

200-98
Fig. 6
Splitting Forceps

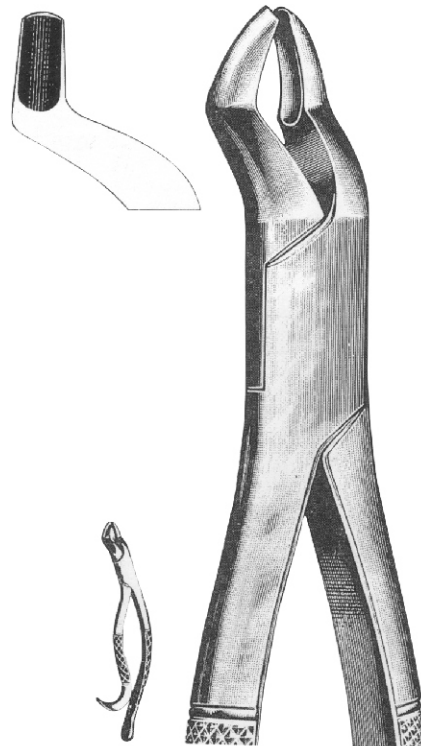

200-99
Fig. 10 H
Upper Molars
Hook - Handle

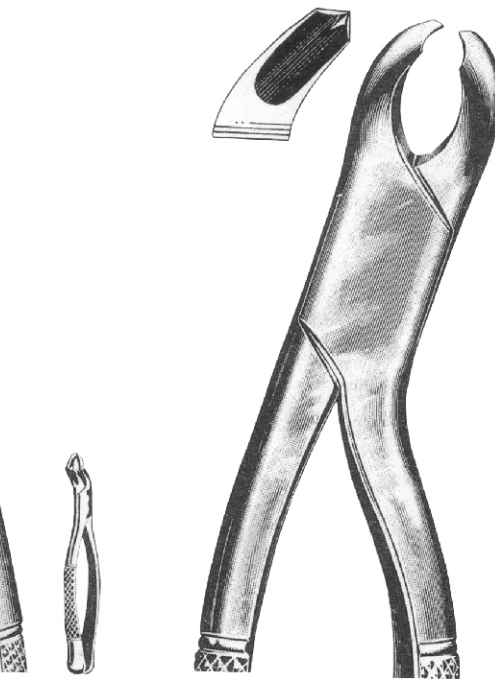

200-100
Fig. 10 S
Upper Molars
Straight - Handle

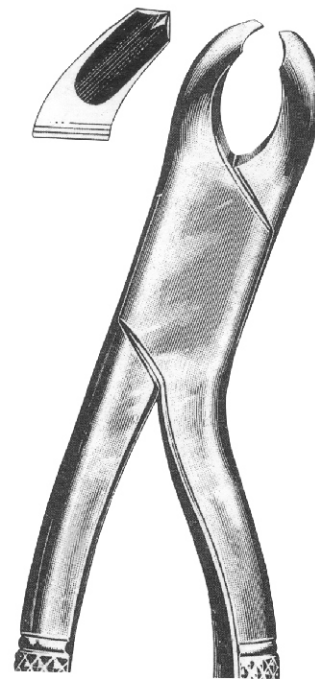

200-101
Fig. 15
Lower Molars

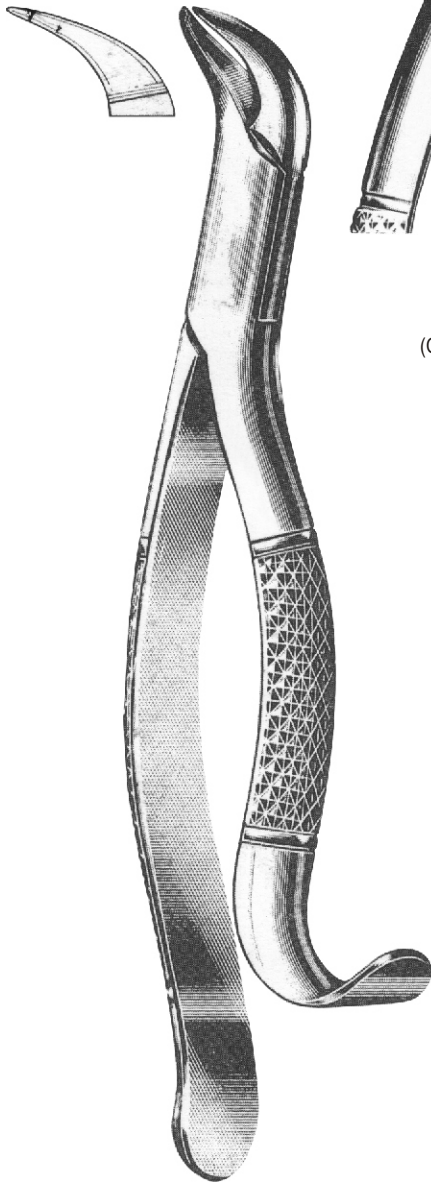

200-102
Fig. 16 S
Lower Molars
Children

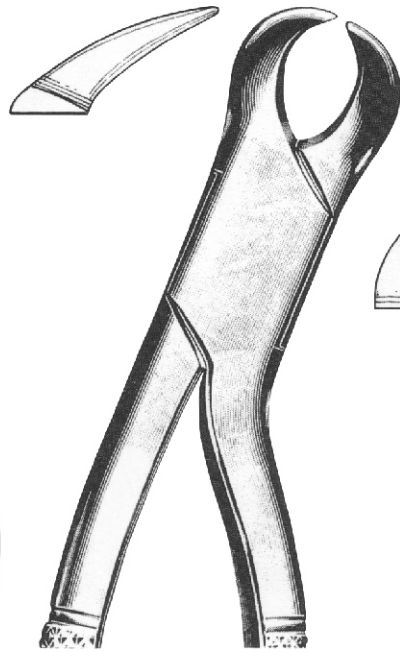

200-103
Fig. 16
Lower Molars
(Cow-Horn Beak)

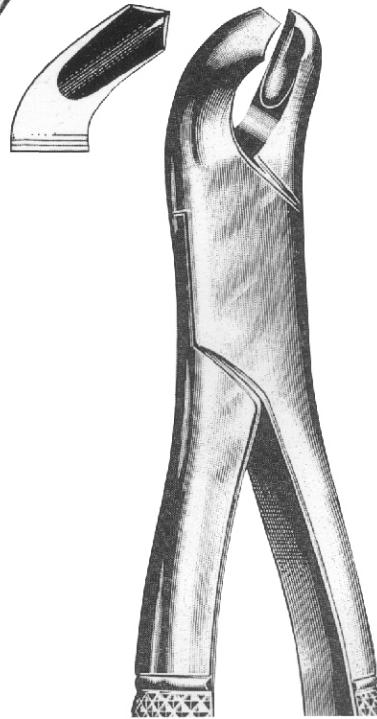

200-104
Fig. 17
Lower Molars

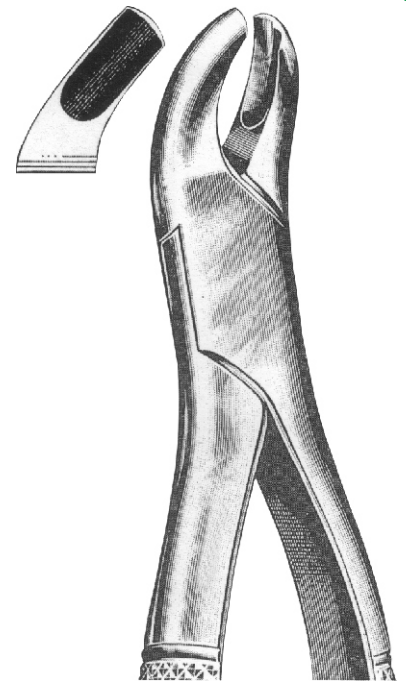

200-105
Fig. 18L
Upper Molars
Left Side

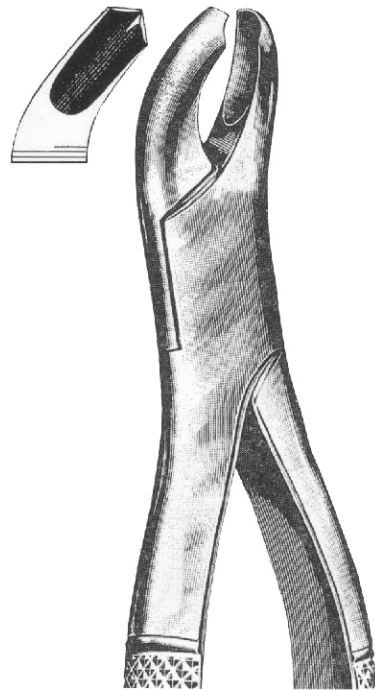

200-106
Fig. 18R
Upper Molars
Right Side

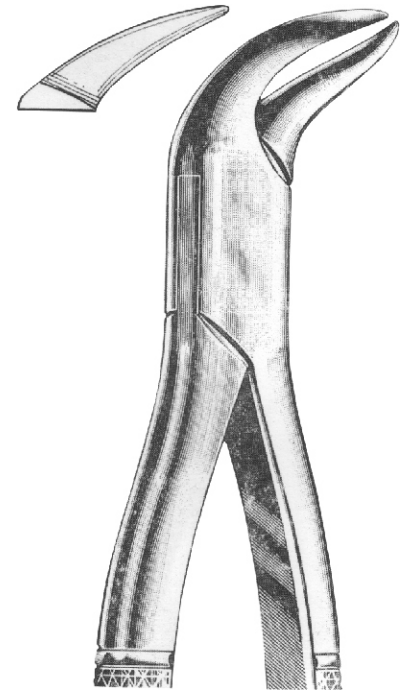

200-107
Fig. 23
Lower Molars
(Cow-Horn Beak)

Extracting Forceps American Pattern

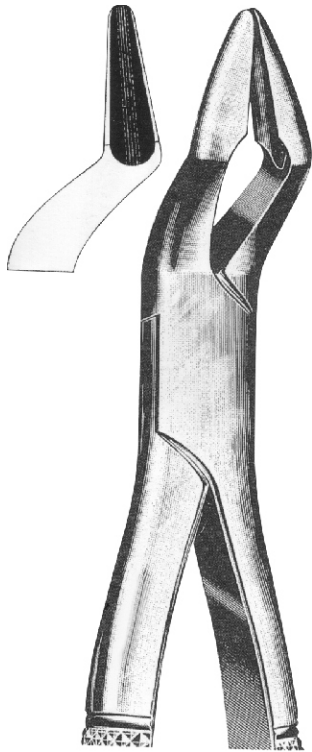

200-108
Fig. 32
Upper Molars & Pre Molars
Strong Beak

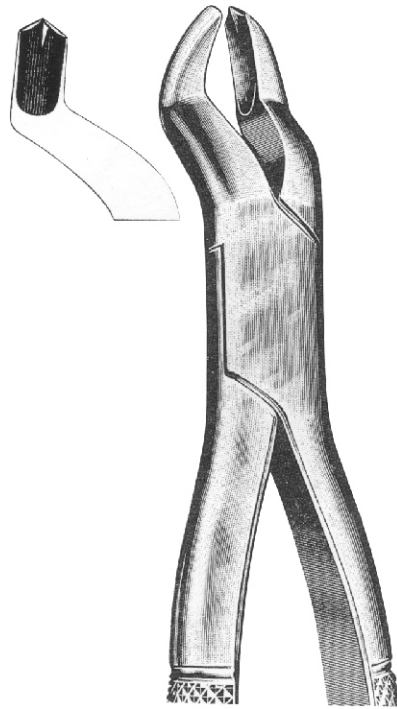

200-109
Fig. 53 L
Upper Molars
Left Side

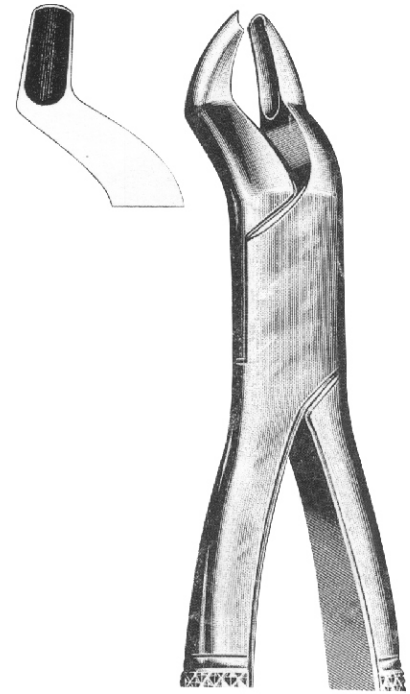

200-110
Fig. 53 R
Upper Molars
Right Side

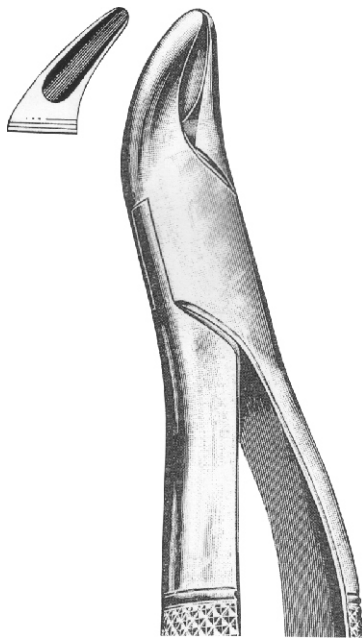

200-111
Fig. 62
Universal Forceps
For Upper Teeth & Roots

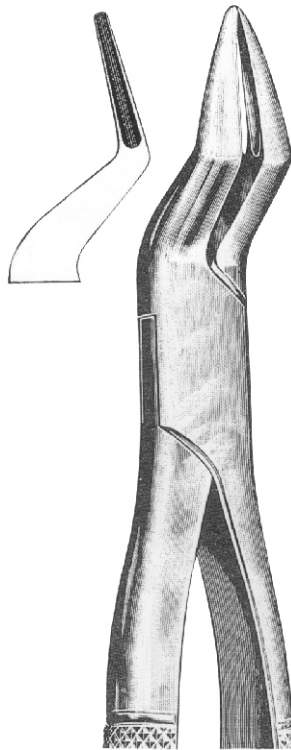

200-112
Fig. 65
Upper Incisors & Root

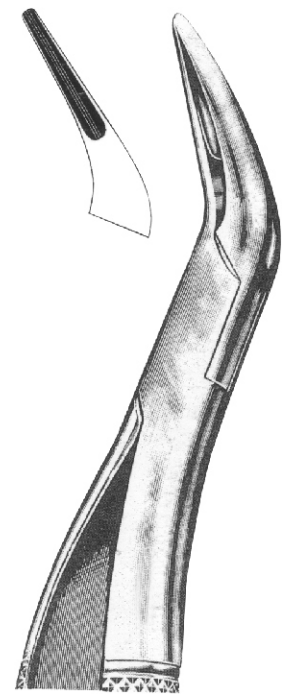

200-113
Fig. 69
Fragments & Small Roots
Upper & Lower

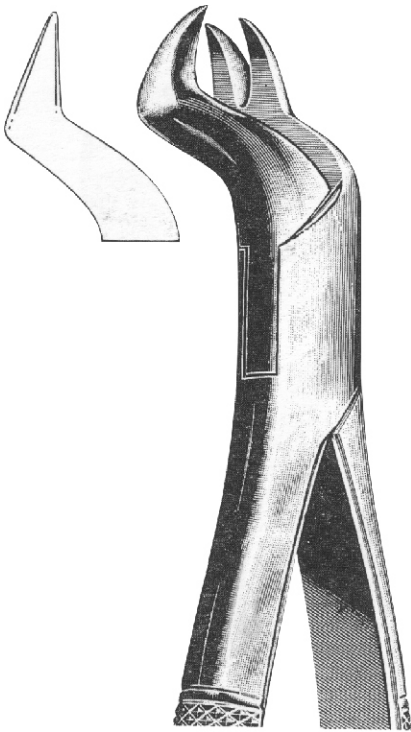

200-114
Fig. 88R
Right Upper Molars

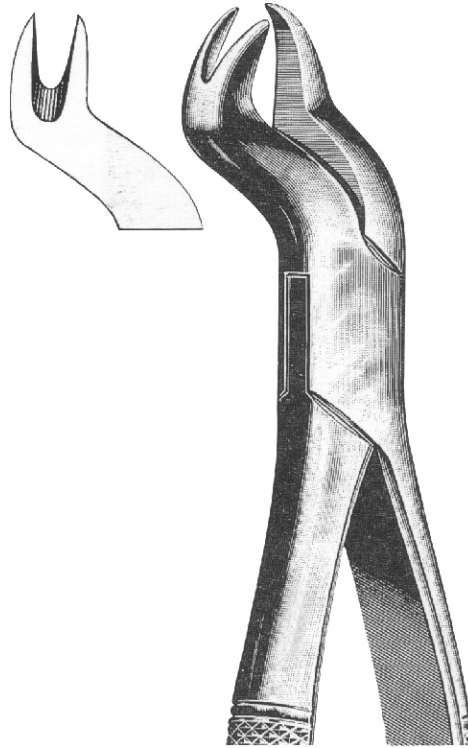

200-115
Fig. 88L
Left Upper Molars

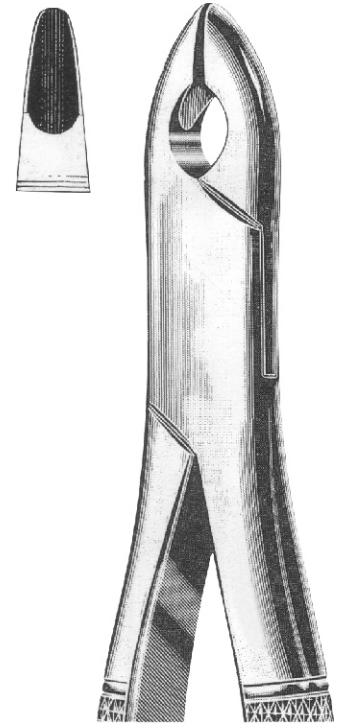

200-116
Fig. 99C
Upper Premolars,
Molar & Incisors

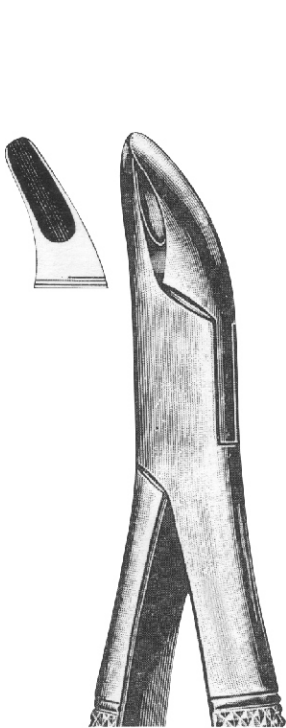

200-117
Fig. 101
Universal Forceps
For Premolars

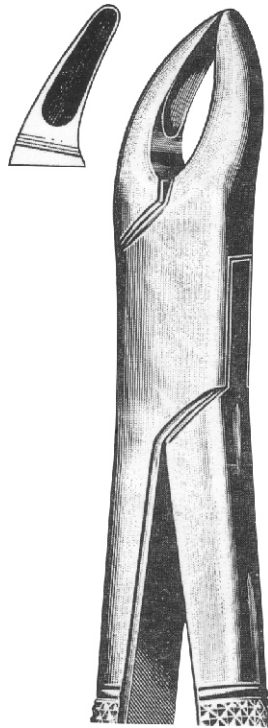

200-118
Fig. 150
Upper Premolars,
Incisors & Roots

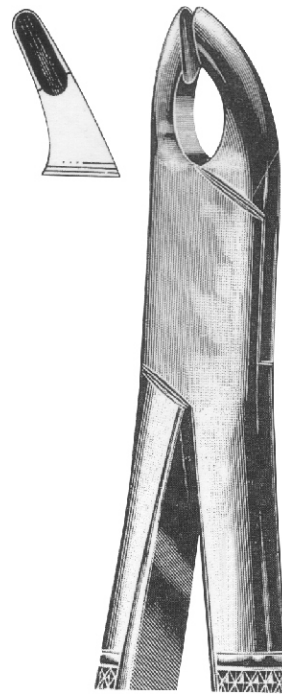

200-119
Fig. 150A
Upper Premolars,
Incisors & Roots

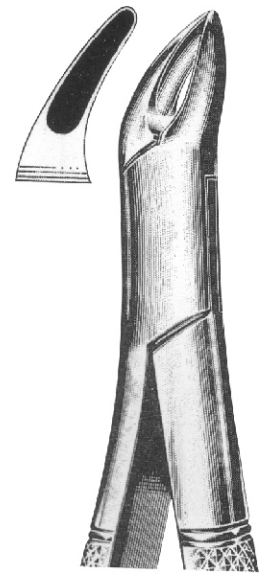

200-120
Fig. 150S
Upper Premolars, Incisors &
Roots For Children

Extracting Forceps American Pattern

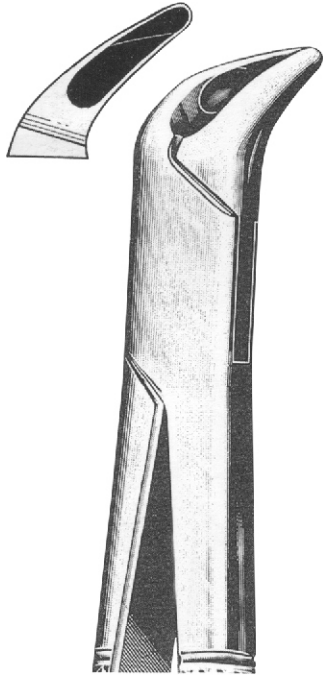

200-121
Fig. 151
Lower Premolars,
Incisors & Roots

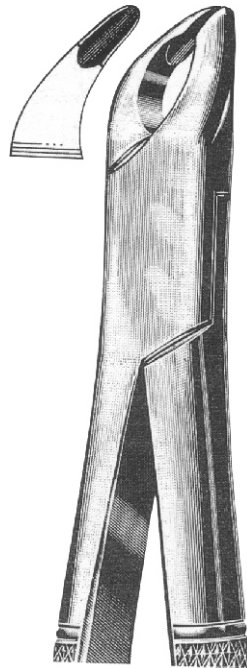

200-122
Fig. 151A
Lower Premolars,
Incisors & Roots

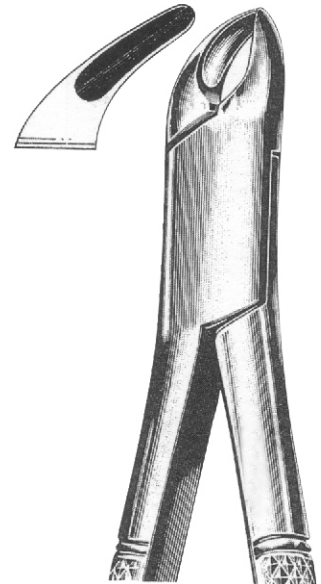

200-123
Fig. 151S
Lower Premolars, Incisors
& Roots For Children

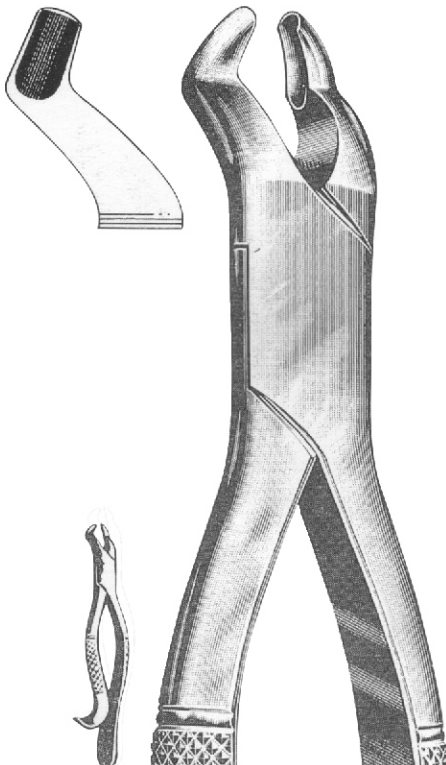

200-124
Fig. 210H
Upper Wisdoms
With Hook Handle

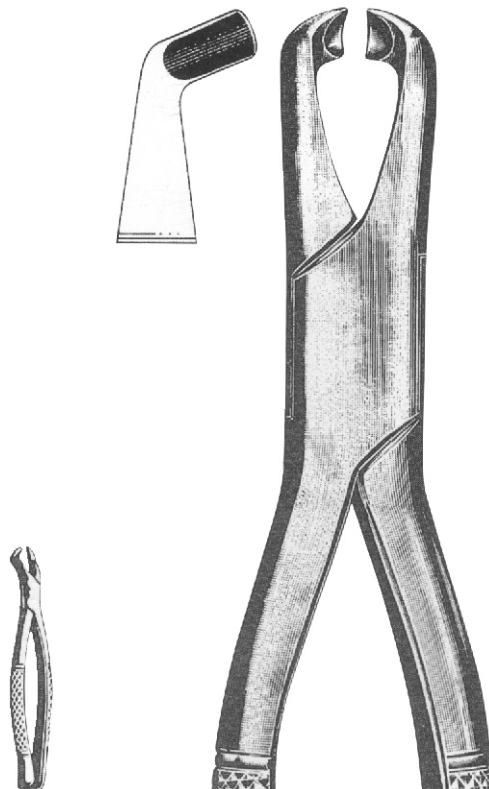

200-125
Fig. 210S
Upper Wisdoms
With Straight Handle

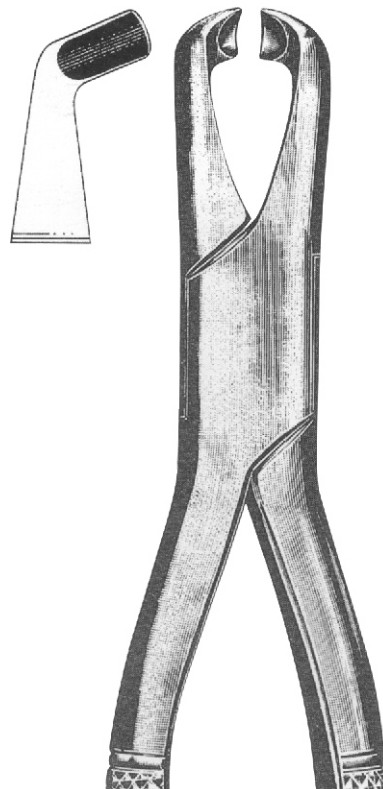

200-126
Fig. 222
Lower Wisdoms

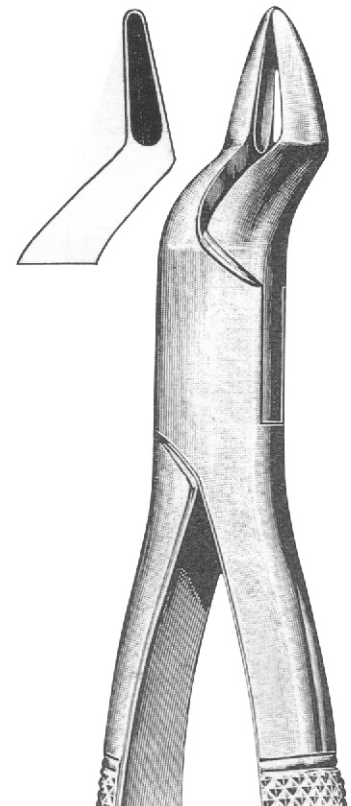

200-127
Upper Roots,
Premolars & Incisors

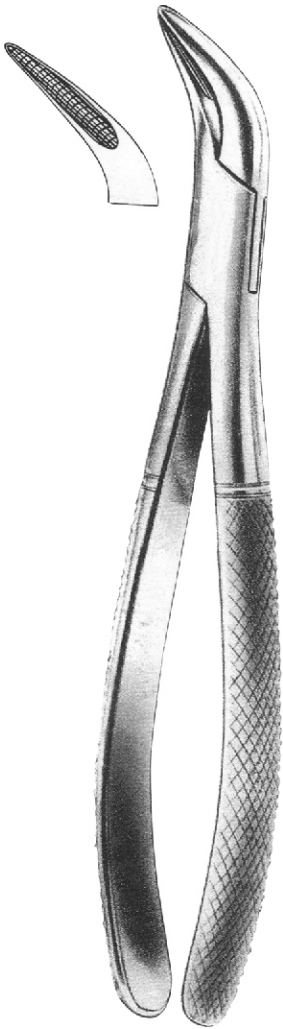

200-128
Fig. 1
Lower Roots

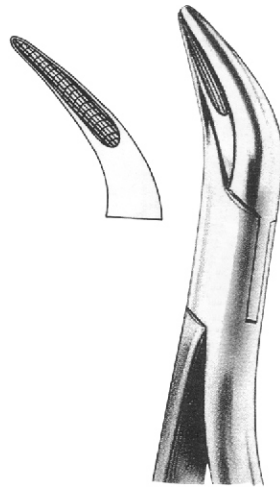

200-129
Fig. 2
Upper Roots



200-130
Albrecht
16cm



200-131
Albrecht
16cm

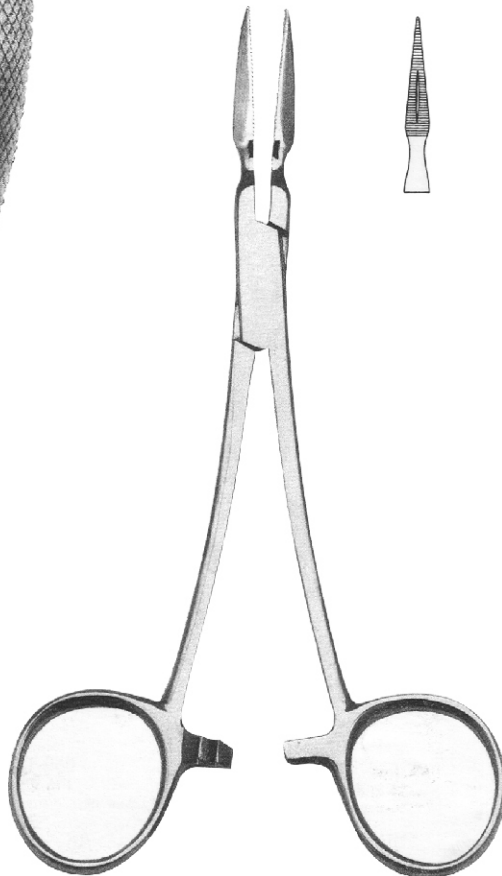

200-132
Fig. 1
Root Fragments



200-133
Fig. 2
Root Fragments



SECTION #03

Root Elevators : Page 33 to 38

Root Elevators

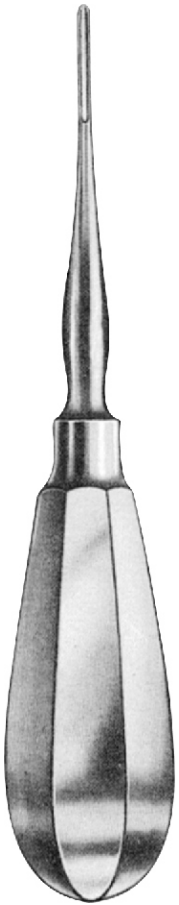

300-01
Bein
2mm



300-02
3mm



300-03
mm



300-04
5mm



300-05
2mm



300-06
3mm



300-07
4mm

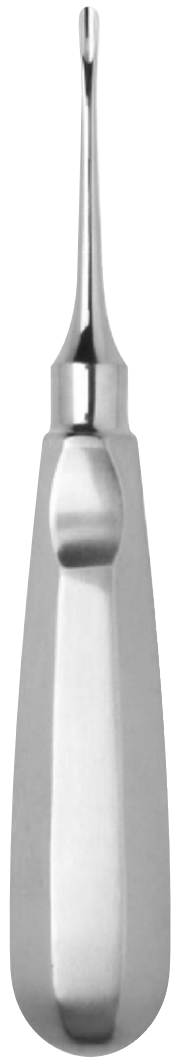

300-08
Apical



300-09
Apical



300-10
Apical



300-11
Apical



300-12
Flohr



300-13
Flohr



300-14
Flohr



300-15
Seldin



300-16
Seldin



300-17
Miller



300-18
Miller



300-19
Miller



300-20
Miller

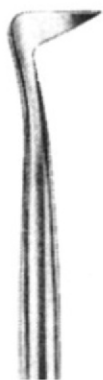

300-21
Seldin

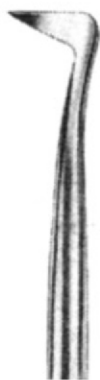

300-22
Seldin



300-23
Seldin



300-24
Seldin



300-25
Cryer



300-26
Cryer



300-27
Cryer



300-28
Cryer

Root Elevators



300-29



300-30



300-31



300-32
Flohr



300-33
Flohr

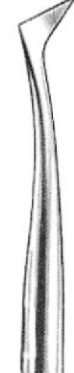

300-34
Cryer



300-35
Cryer

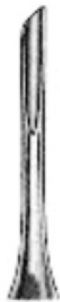

300-36



300-37



300-38



300-39



300-40

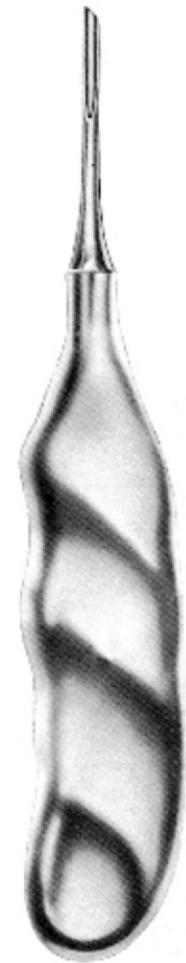

Anatomical Handle



300-41



300-42



300-43



300-44

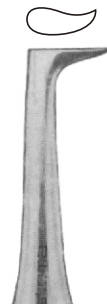

300-45

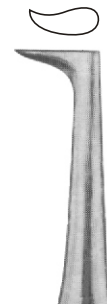

300-46



Coupland



300-47
2mm

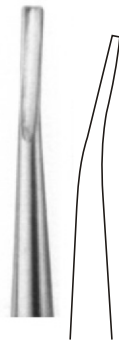

300-50
2mm



300-48
3mm

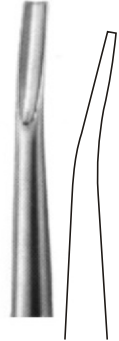

300-51
3mm



300-49
4mm



300-52
4mm



300-53
Warwick-James



300-54
Warwick-James



300-55
Warwick-James



300-56
Lecluse



300-57
Barry



300-58
Barry



300-61
Barry



300-62
Barry



300-59
Barry



300-60
Barry



300-63
Barry



300-64
Barry

Root Elevators

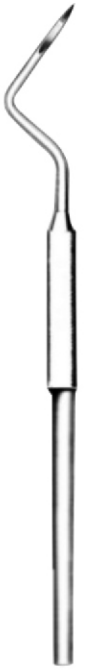

300-65
Heidbrink



300-66
Heidbrink



300-67
Heidbrink



300-68
Heidbrink



300-69
Heidbrink



300-70
Heidbrink



300-71
Heidbrink



300-72
Heidbrink



300-73
Heidbrink



Kopp



300-74



300-75



300-76



300-77



300-78
Hyllin
2mm



300-79
3mm



300-80
4.5mm



300-81
3mm



300-82
3mm



Chompret



300-83



300-84



300-85



300-86



300-87



300-88

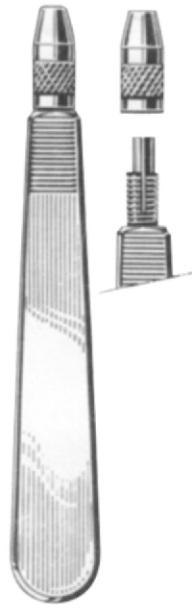

300-89
11cm



Fig.0



Fig.1



Fig.2



Fig.3



Fig.4



Fig.5



Fig.6



Fig.7



Fig.8



Fig.9



11



21



22



23



24



25



26



27



28



29



SECTION #04

Tweezers : Page 39
Surgical Scissors : Page 40

Tweezers



400-01
Meriam
16cm



400-02
College
15cm



400-03
Flagg
15cm



400-04
Perry
13cm



400-05
Perry
13cm



400-06
College
16cm



400-07
Meriam
16cm



Iris
11.5cm



400-08



400-09

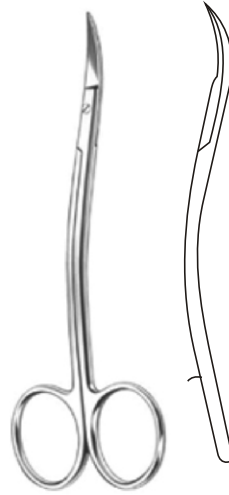

400-12
La-Grange
11.5cm



13cm



400-13



400-14



400-10



400-11



400-15 9cm
400-16 11cm
400-17 13cm
Spencer



Crown
10.5cm



400-18



400-19



Noyes



400-20
11cm



400-22
15cm



400-21
11cm



400-23
15cm



Noyes
14.5cm



400-24



400-25



400-26

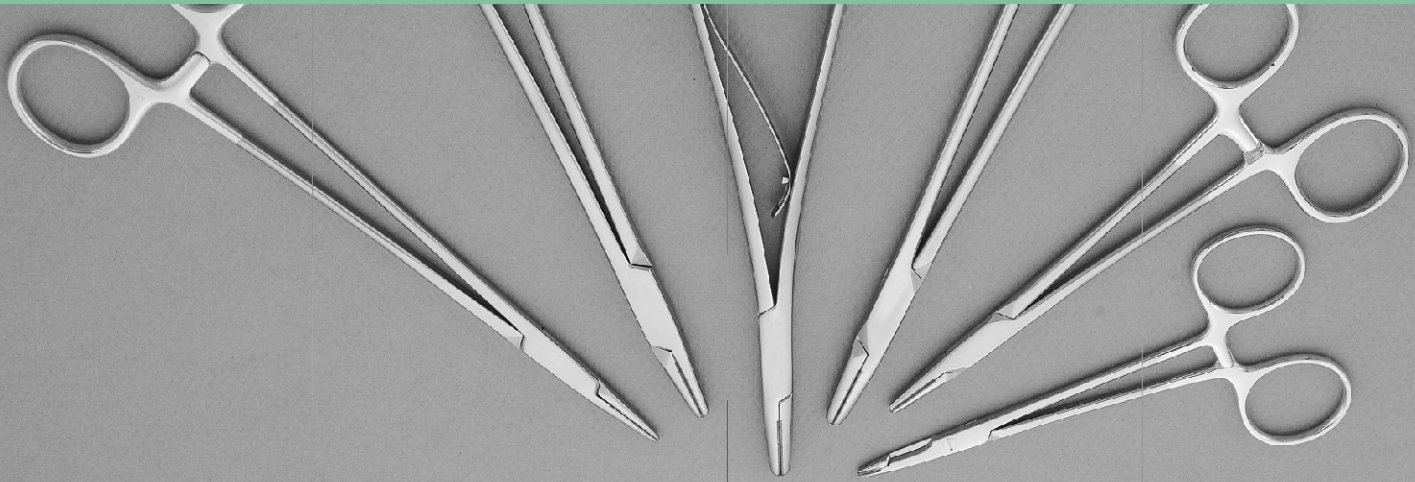

SECTION #05

Haemostatic Forceps: Page 41
Needle Holders Tc Page 42 to 44

Haemostatic Forceps

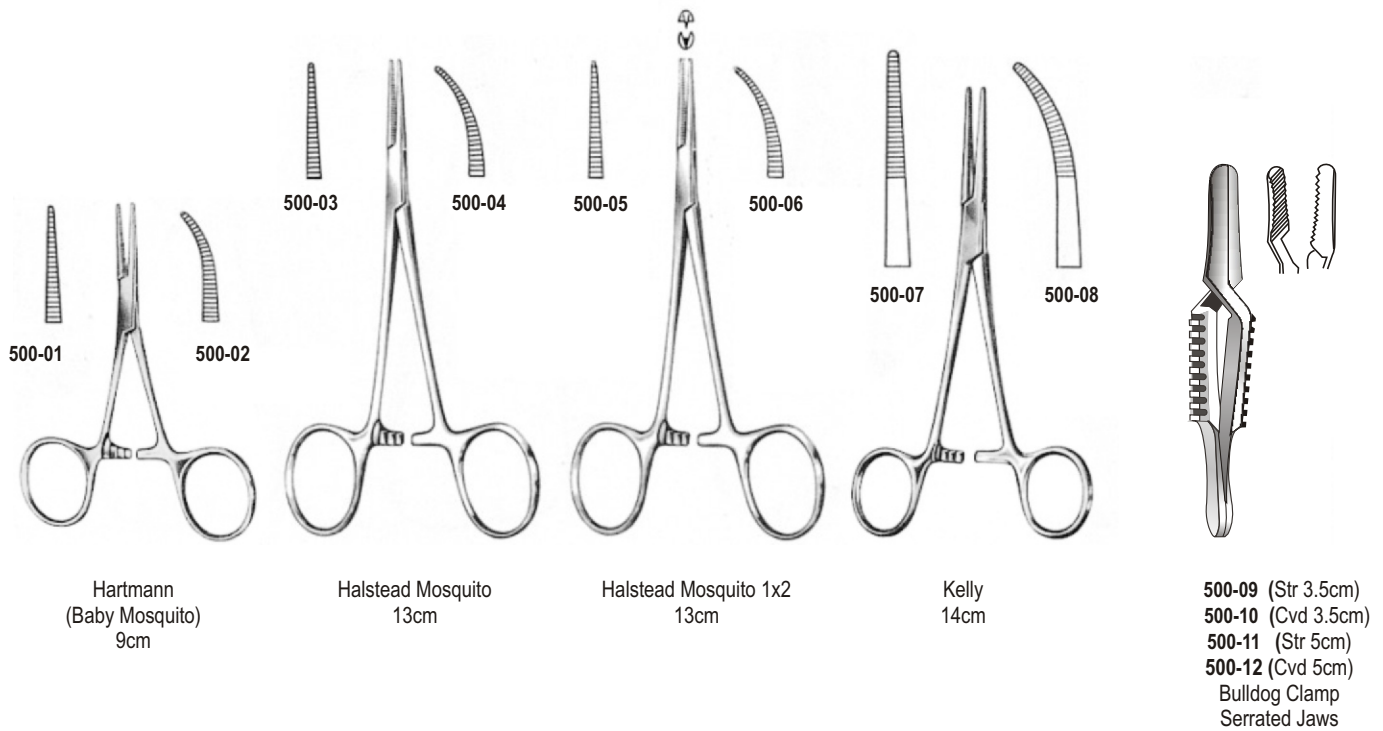



Ryder (Martin)



500-13
3cm



500-14
15cm

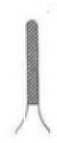

500-15
18cm



500-16
13cm



500-17
15cm



500-18
18cm

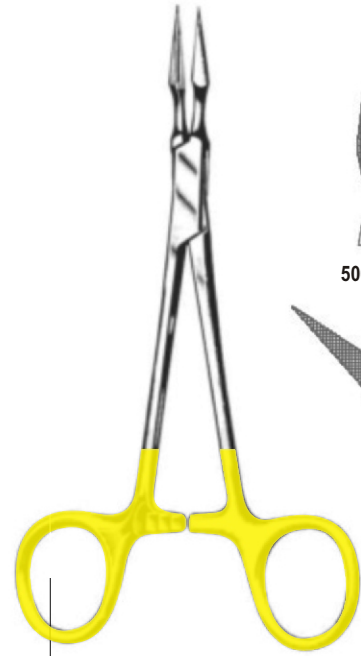

Stieglitz
15.5cm



500-19



500-20



Olsen-Hegar



500-21
14cm



500-22
16.5cm



Gillies



500-23
12cm



500-24
16cm



Olsen-Mathieu



500-25
14cm



500-26
16.5cm



500-27
Boynton
12cm

Needle Holders Tc



Castroveijo



Castroveijo
(With Lock)



Castroveijo
(Without Lock)



Angled



Castroveijo
With Scissor



Barraquer





500-50
16cm

500-51
18cm

500-52
20cm

Langenback



500-53
14cm

500-54
17cm

500-55
20cm

Mathieu



500-56
14cm

500-57
17cm

500-58
20cm

Mathieu



500-59
14cm

500-60
17cm

500-61
20cm

500-62
14cm

500-63
17cm

500-64
20cm

Lichtenberg-Ryder



500-65

500-66

Arruga
16cm

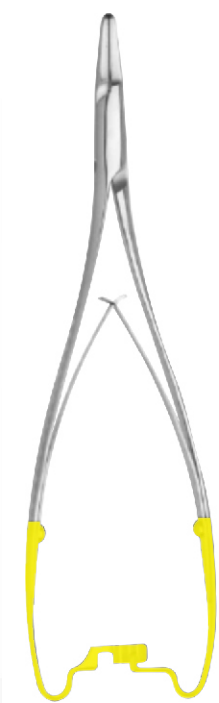

500-67

500-68

Lichtenberg 17cm

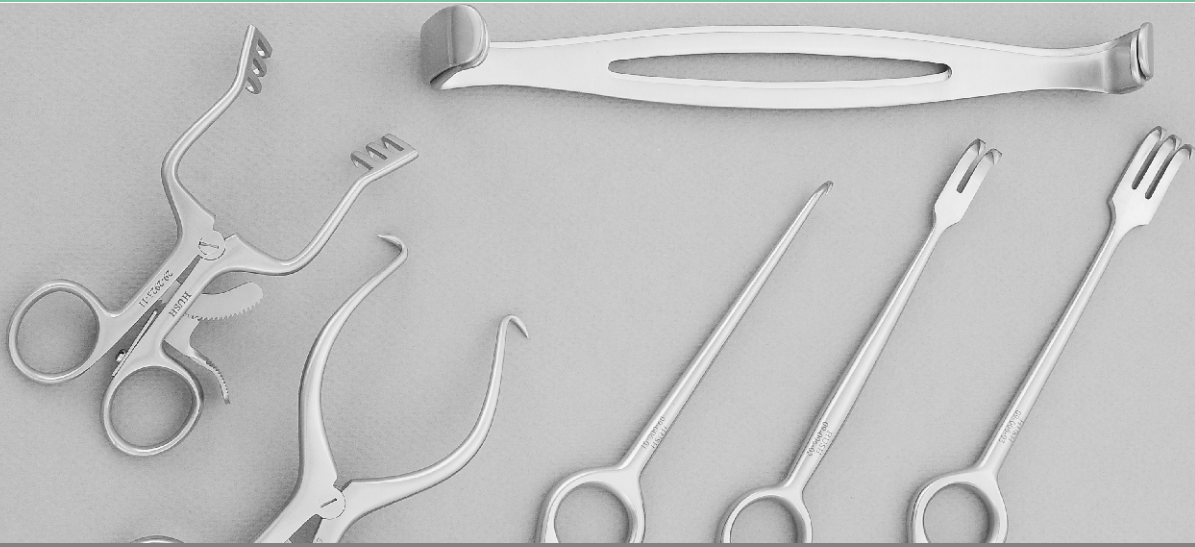

SECTION #06

Retractors: Page 45 to 46
Retractors / Mouth Gags / Speculum: Page 47
Retractors / Tongue Depressor: Page 48

Retractors



600-01
40x11mm

600-02
55x11mm

Kocher
21cm

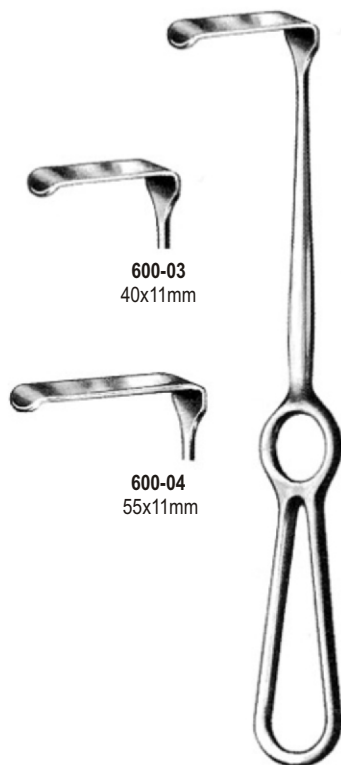

600-03
40x11mm

600-04
55x11mm

Kocher
21cm



600-05
14x17mm

600-06
20x22mm

600-07
26X30mm



Middledorf
19cm



600-08 Right
600-09 Left
Sinus Lifting
Retractor
22cm



Nentwig
22cm



600-10 14mm Left
600-11 23mm Left



600-12 14mm Right
600-13 23mm Right



600-14
Bowdler-Henry
19cm



600-15
Ivory



600-16 Small 40 x 105mm
600-17 Medium 50 x 110mm
600-18 Large 60 x 115mm
Oringer



Roux
600-19 14cm
(20x28mm)
600-20 15cm
(26x36mm)
600-21 18cm
(29x43mm)



600-22 14cm
(28mm)
600-23 15cm
(32mm)
Wieder



600-24
75x15mm
Austin

Retractors / Mouth Gags / Speculum

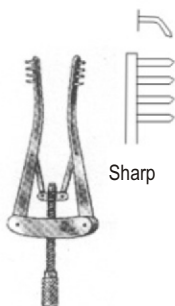

600-25
Alm
7cm

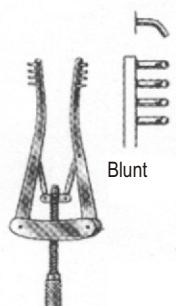

600-26
Alm
7cm

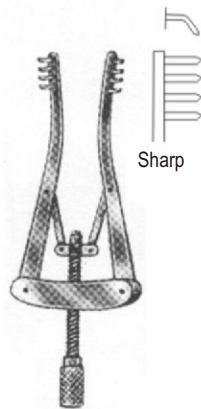

600-27
Alm
10cm

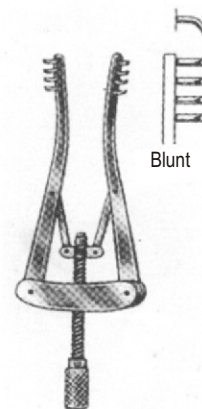

600-28
Alm
10cm

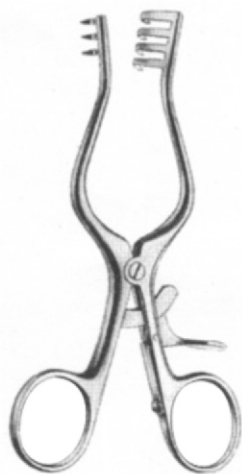

600-29
Collin Sharp
13cm



600-30
Collin Blunt
13cm



600-31
Roser-Koeing
16cm



600-32 09cm
600-33 11cm
600-34 14cm
Molt



600-35



600-36



600-37



Hartmann-Halle
15cm



600-38
Denhart
12cm

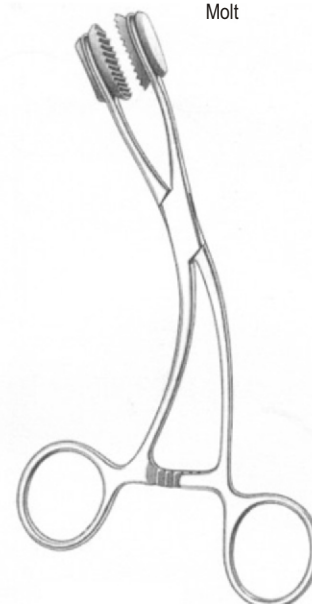

600-39
Young
17cm



600-40
Columbia
14cm



600-41
Sternberg
14cm



600-42
Universal Retractor
17cm



600-43
Sternberg
14cm



600-44 12cm
600-45 14cm
Farebeuf



600-46
Brunings
19cm



600-47
10x6mm



600-48
20x8mm



Senn-Green
15cm



600-49
Cowood
15cm



600-50
University of
Minnesota
14cm



600-51
Ragnell-Davis
16cm



600-52
Sharp
16cm



Senn-Muller

600-53
Blunt
16cm

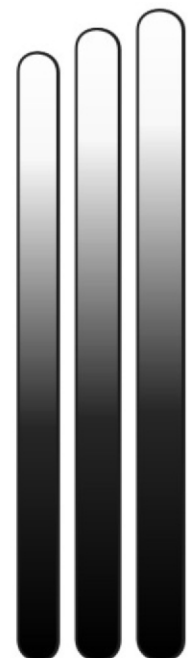

200x15 200x20 200x25

600-54
Kit 3Pcs



SECTION #07

Mirrors Handles:	Page 49	Cavity Preparation Instruments:	Page 55
Mirrors / Amalgam Carvers:	Page 50	Amalgam Carvers:	Page 56
Explorers:	Page 51 to 52	Spreaders:	Page 57
Periodontia / Endodontic Instruments:	Page 53	Filling Instruments:	Page 58 to 60
Cement, Heidemann Spatulas:	Page 54	Periodontia Instruments / Surgical Mallets & Hammers:	Page 61 to 64

Mirrors Handles



700-01



700-02
Hollow



700-03



700-04
Hollow



700-05
Nylon
Autoclavable
Available in 7 colors

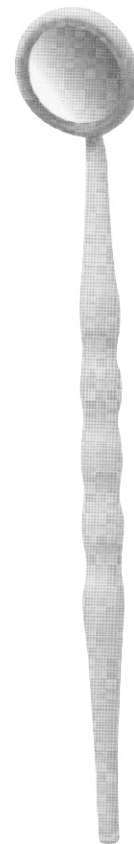

700-06
Nylon
Autoclavable
Available in 7 colors



700-07
Hollow



700-08
Plane 3 20mm
Plane 4 22mm
Plane 5 24mm



700-09
Magnifying 3 20mm
Magnifying 4 22mm
Magnifying 5 24mm



700-10
Plane 3 20mm
Plane 4 22mm
Plane 5 24mm



700-11
Magnifying 3 20mm
Magnifying 4 22mm
Magnifying 5 24mm



700-12
Front Surface
Plane 3 20mm
Plane 4 22mm
Plane 5 24mm



700-13
Front Surface
Plane 3 20mm
Plane 4 22mm
Plane 5 24mm

With Cone Socket



700-14

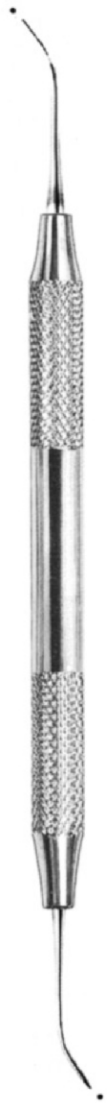

700-15

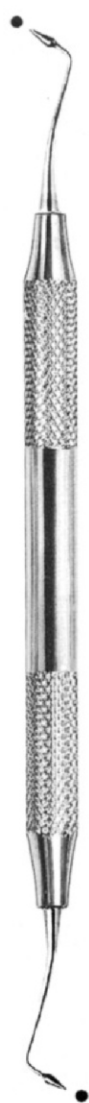

P.K Thomas

700-16

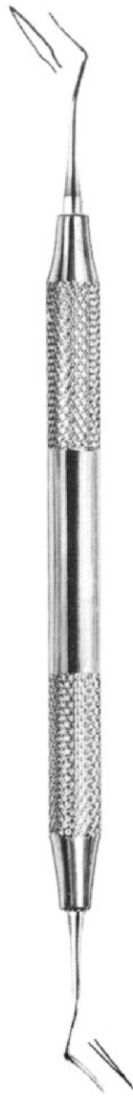

700-17



700-18

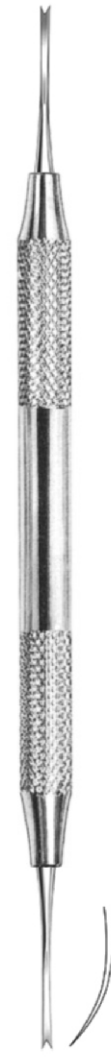

700-19
Luniatschek 2mm
Gauze Packer



700-20
Luniatschek 3mm
Gauze Packer

Explorers

Flexible

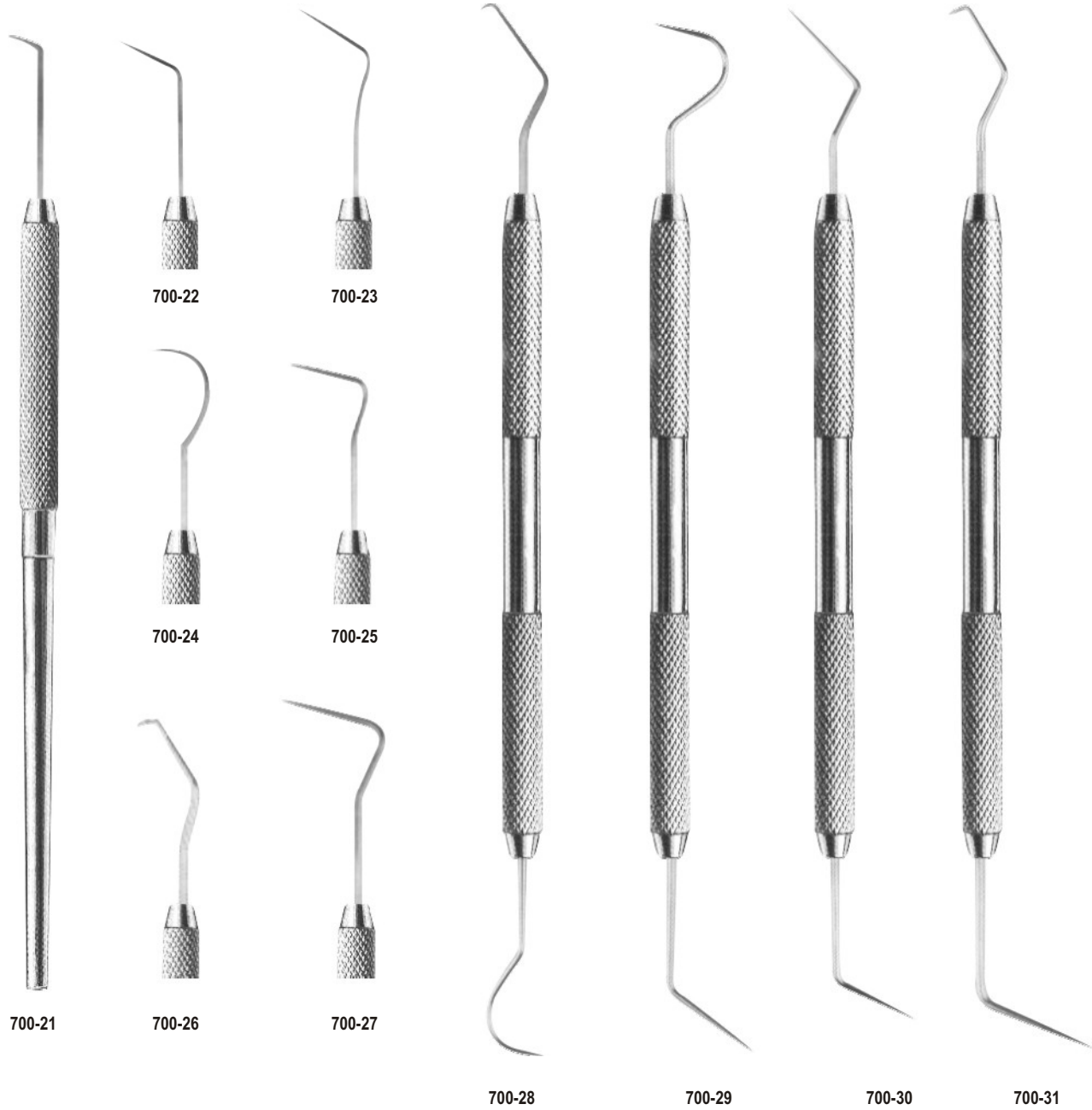

Non Flexible

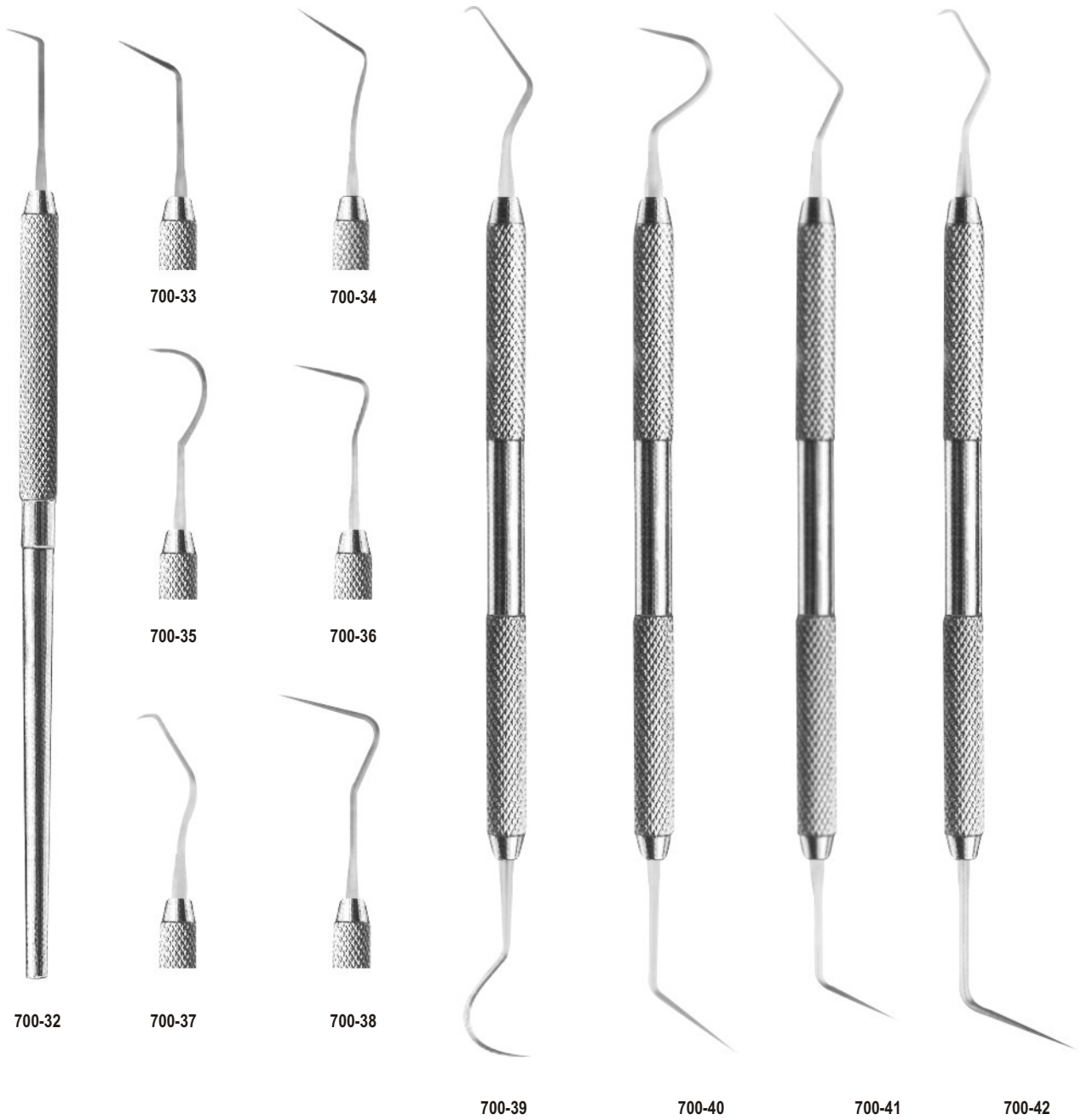

Periodontia / Endodontic Instruments

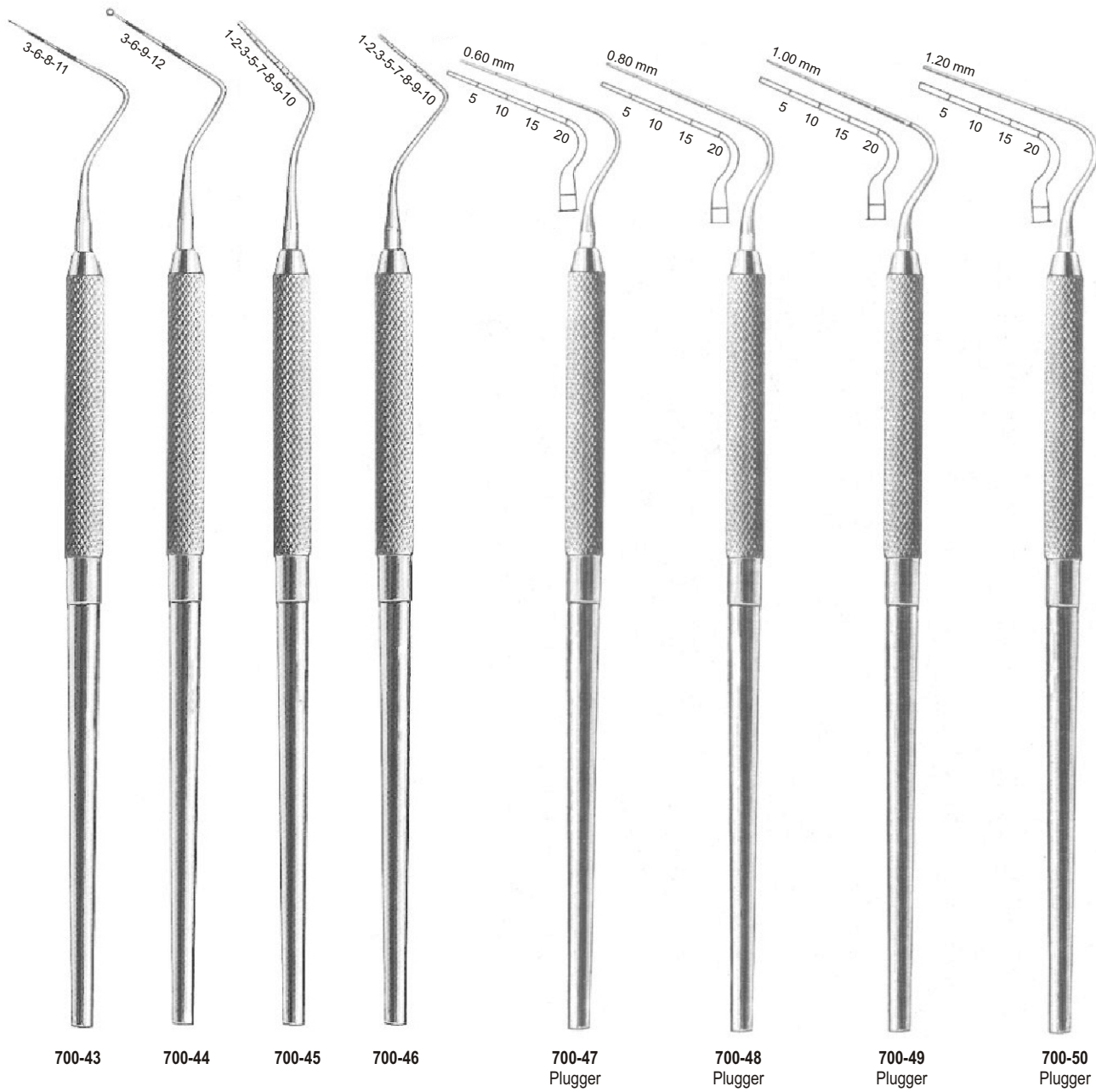

700-43

700-44

700-45

700-46

700-47
Plugger

700-48
Plugger

700-49
Plugger

700-50
Plugger



Cavity Preparation Instruments

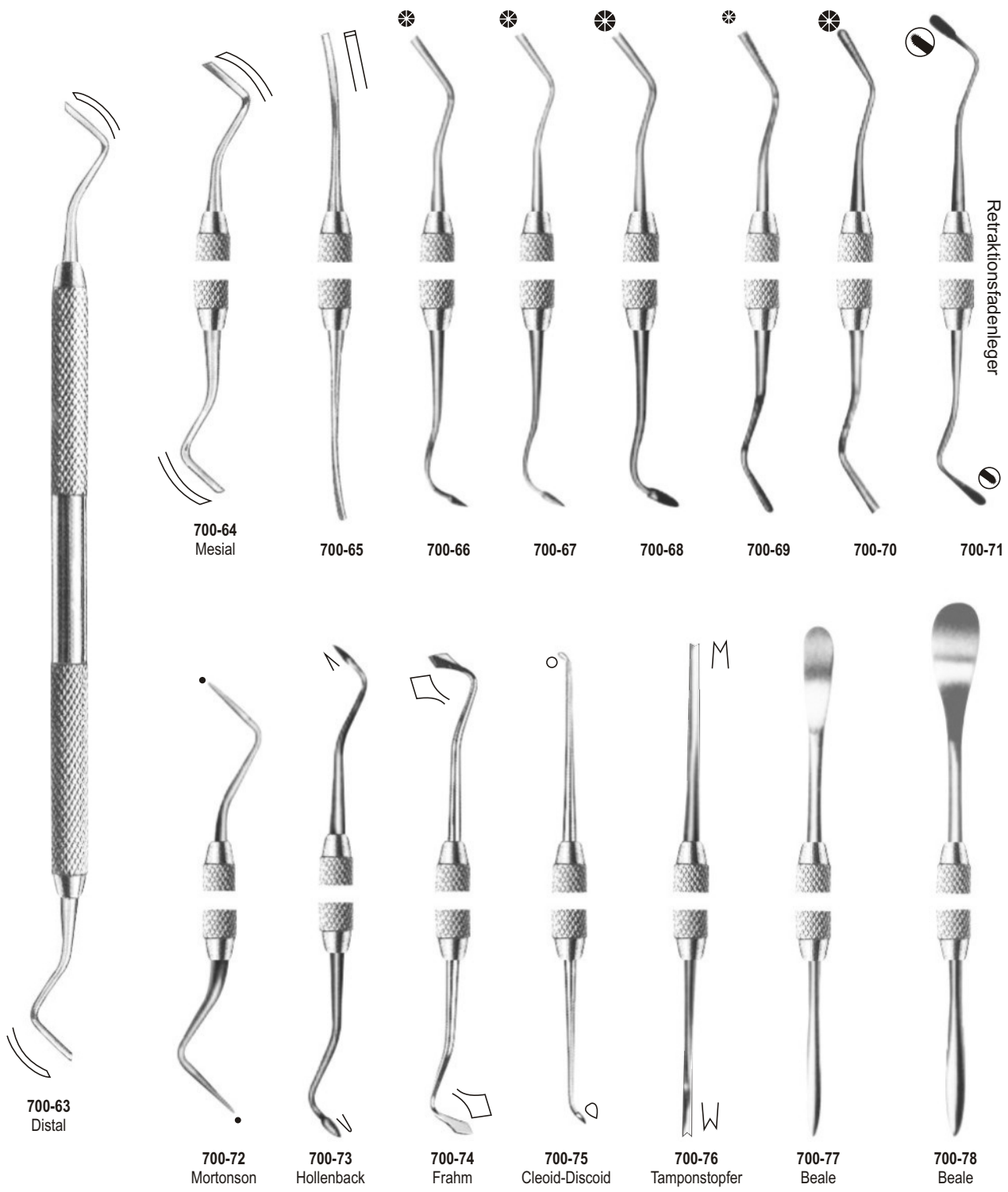

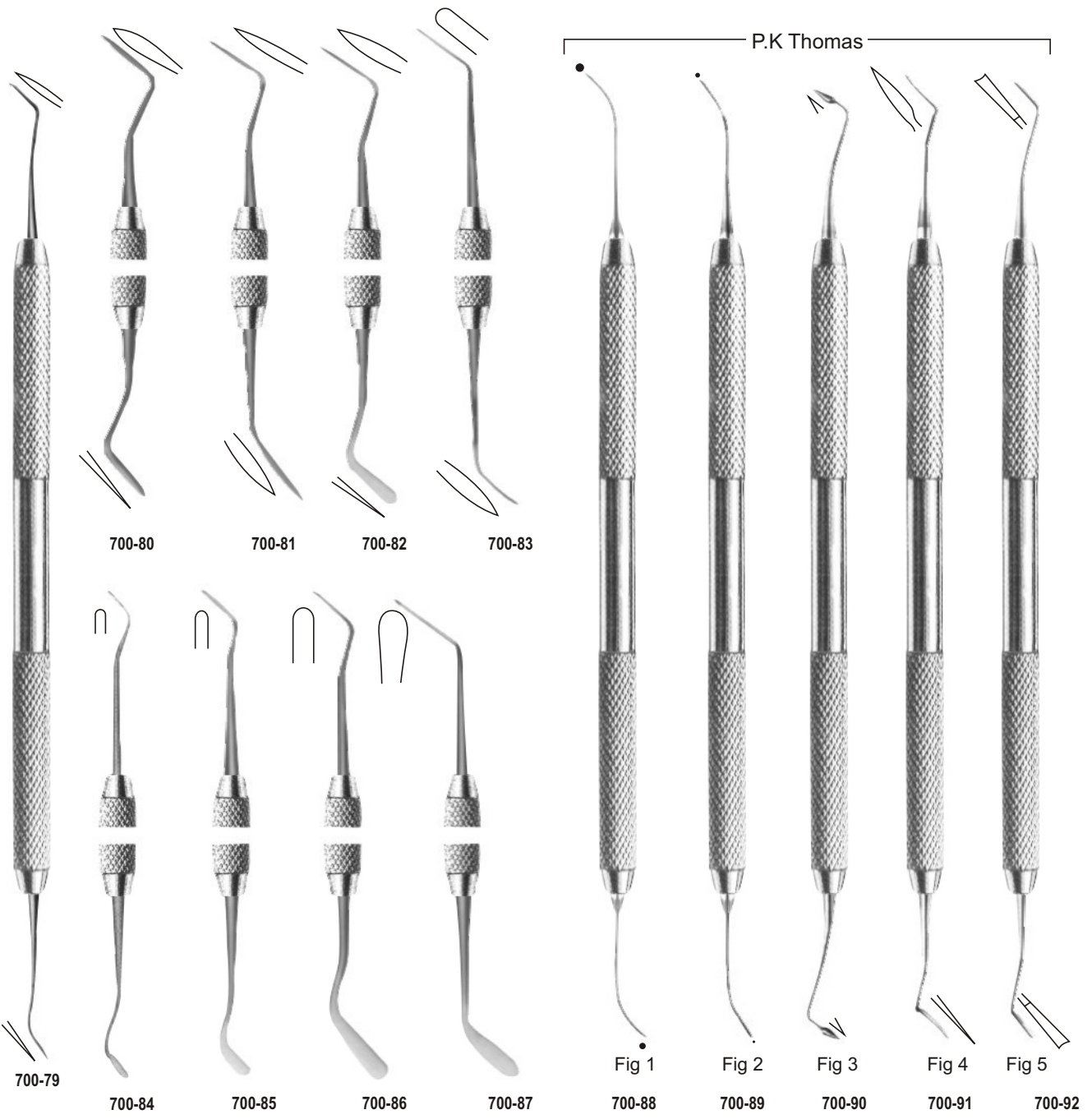

Spreaders



700-93

700-94

700-95

700-96

700-97

700-98

700-99

700-100

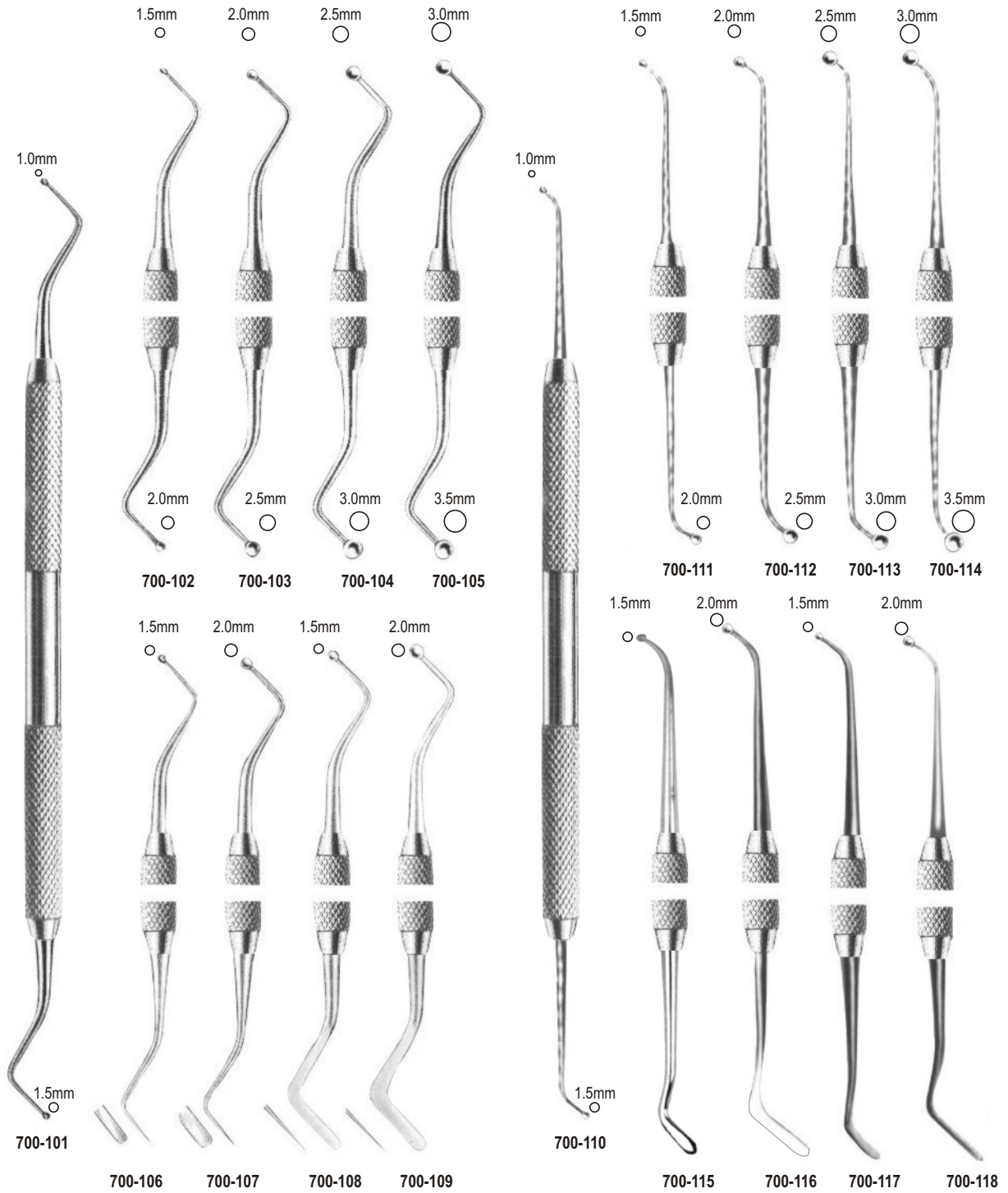

Filling Instruments

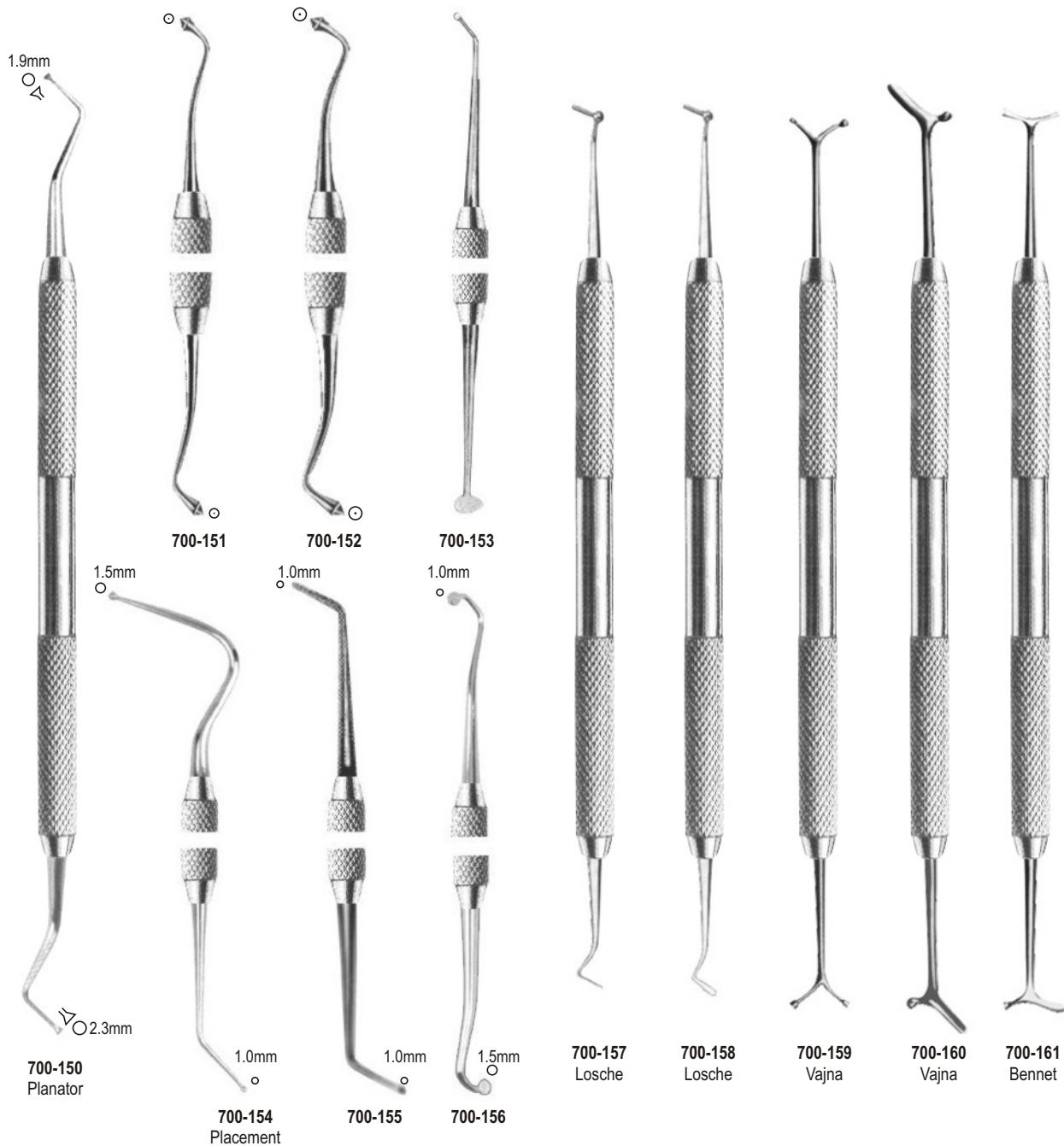

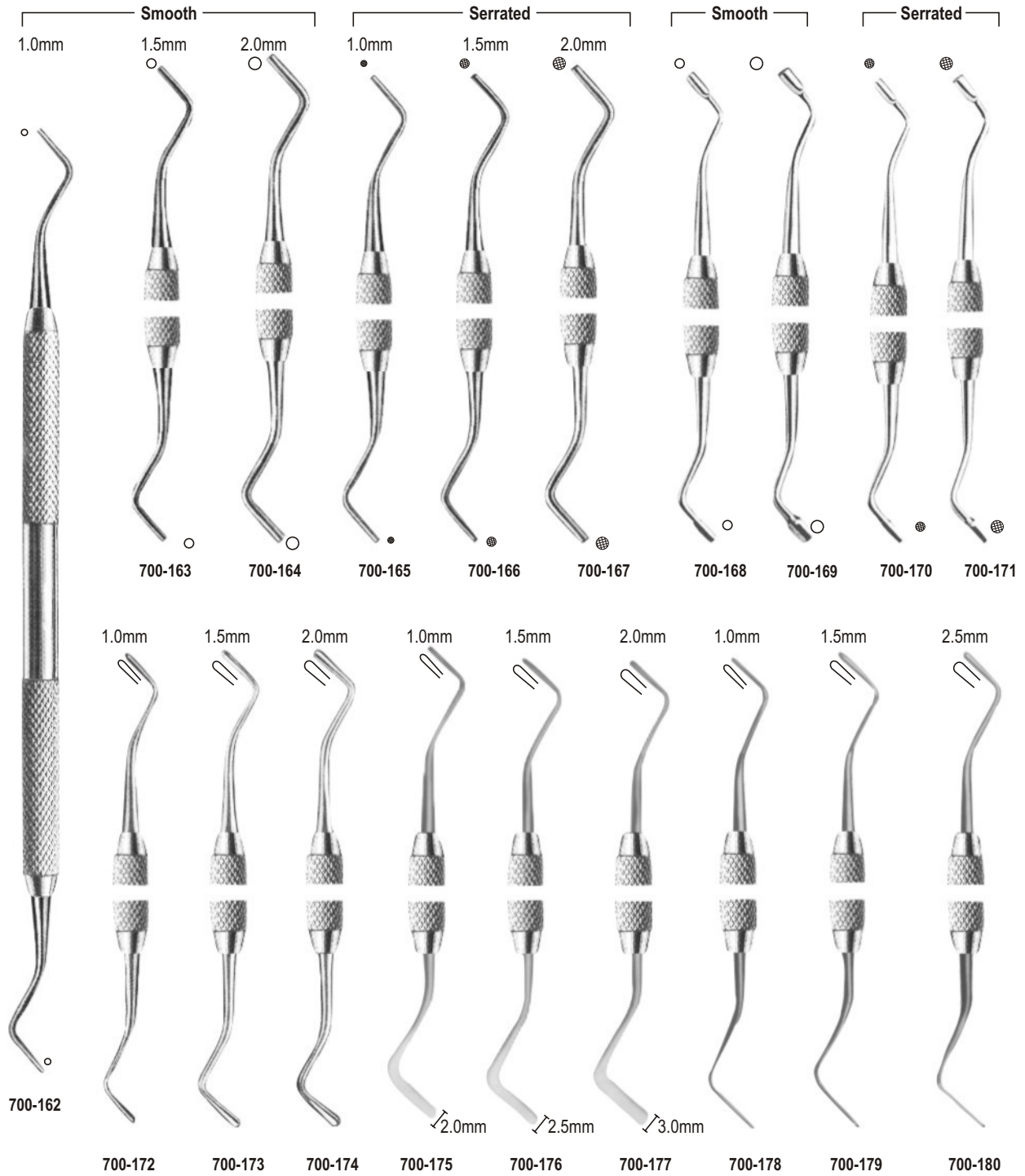

Periodontia Instruments

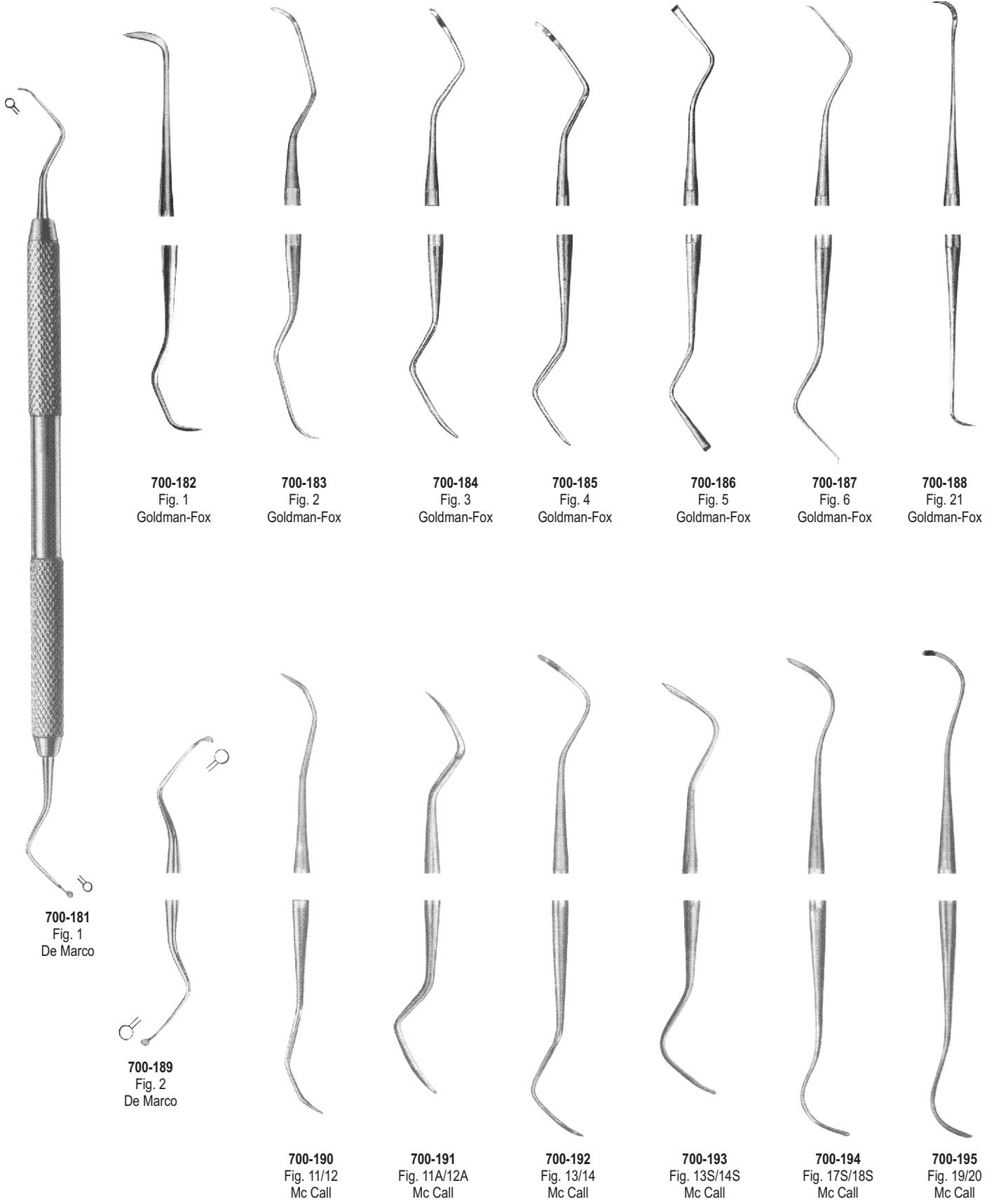

700-182
Fig. 1
Goldman-Fox

700-183
Fig. 2
Goldman-Fox

700-184
Fig. 3
Goldman-Fox

700-185
Fig. 4
Goldman-Fox

700-186
Fig. 5
Goldman-Fox

700-187
Fig. 6
Goldman-Fox

700-188
Fig. 21
Goldman-Fox

700-181
Fig. 1
De Marco

700-189
Fig. 2
De Marco

700-190
Fig. 11/12
Mc Call

700-191
Fig. 11A/12A
Mc Call

700-192
Fig. 13/14
Mc Call

700-193
Fig. 13S/14S
Mc Call

700-194
Fig. 17S/18S
Mc Call

700-195
Fig. 19/20
Mc Call

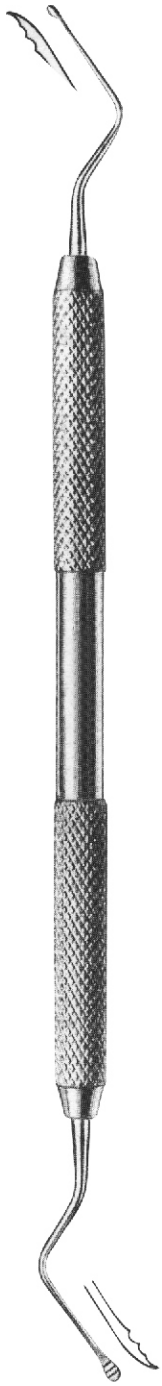

700-196
Fig. 3/7
Hirschfeld
File

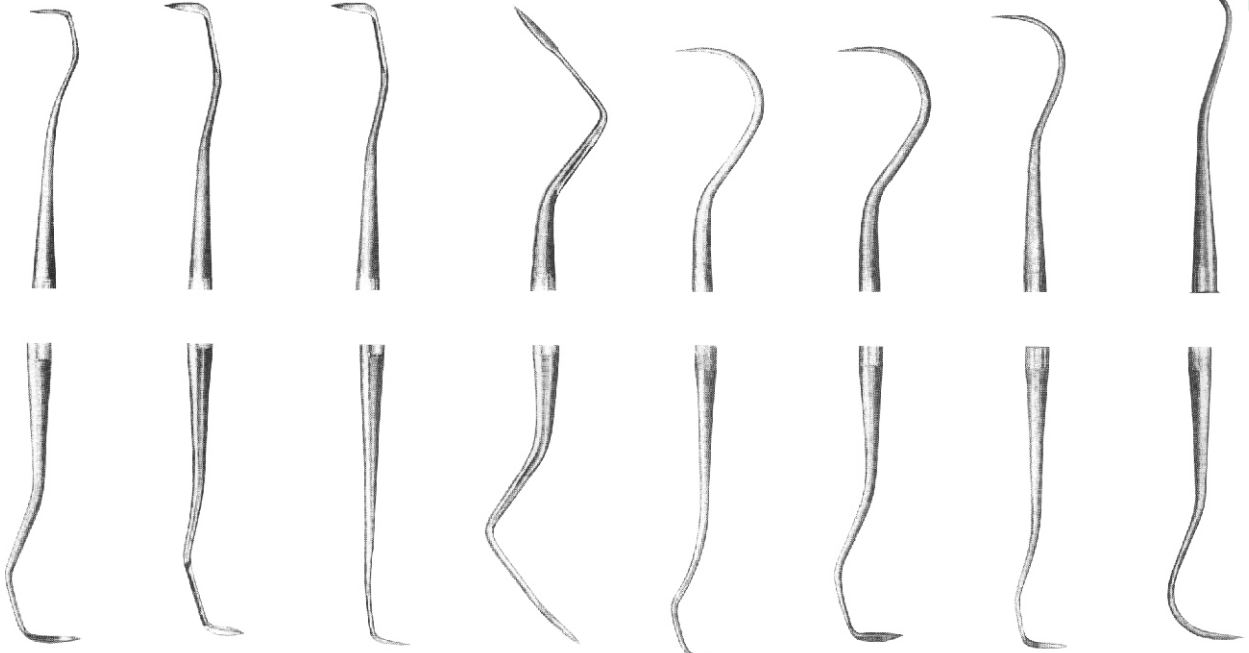

700-197
Fig. 30/33
Jaquette

700-198
Fig. 31/32
Jaquette

700-199
Fig. 34/35
Jaquette

700-200
Fig. 37/38
Jaquette

700-201
Fig. U15/33
Towner Jaquette

700-202
Fig. U15/30
Towner Jaquette

700-203
Fig. H5/30

700-204
Fig. H6/H7

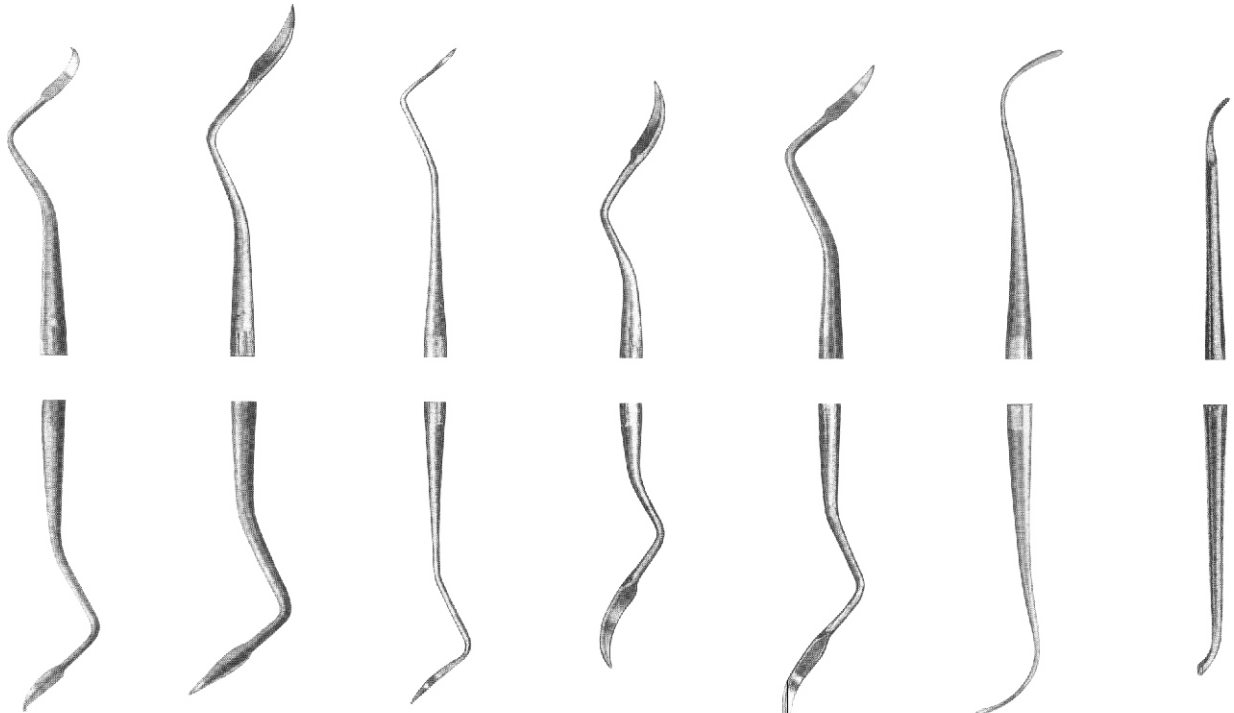

700-205
Fig. 2/3
Taylor

700-206
Fig. 204

700-207
Fig. 204S

700-208
Fig. 2/3

700-209
Fig. 6
Crane-Kaplan

700-210
Fig. 7/8
Younger-Good

700-211
Fig. 1/2

Periodontia Instruments



700-212
Fig. 33



700-213
Fig. 31



700-214
Fig. 32



700-215
Fig. 34



700-216
Fig. 35



700-217
Fig. H5
Hygienist



700-218
Fig. H6
Hygienist



700-219
Fig. H7
Hygienist

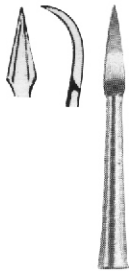

700-220
Fig. 1



700-221
Fig. 1L
Sinistro



700-222
Fig. 1R
Destro



700-223
Fig. 2L
Sinistro



700-224
Fig. 2R
Destro



700-225
Fig. U15
Towner



700-226
Zerfing-Chisel

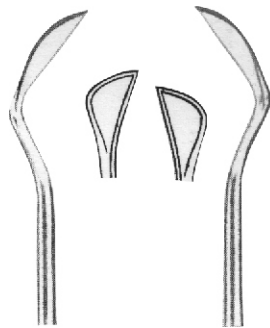

700-227
Fig. 1
(15K)
Kirkland



700-228
Fig. 2
(16K)
Kirkland



700-229
Fig. 1
Orban



700-230
Fig. 2
Orban



700-231
Fig. 1
TG Chisel



700-232
Fig. 2
TG Chisel

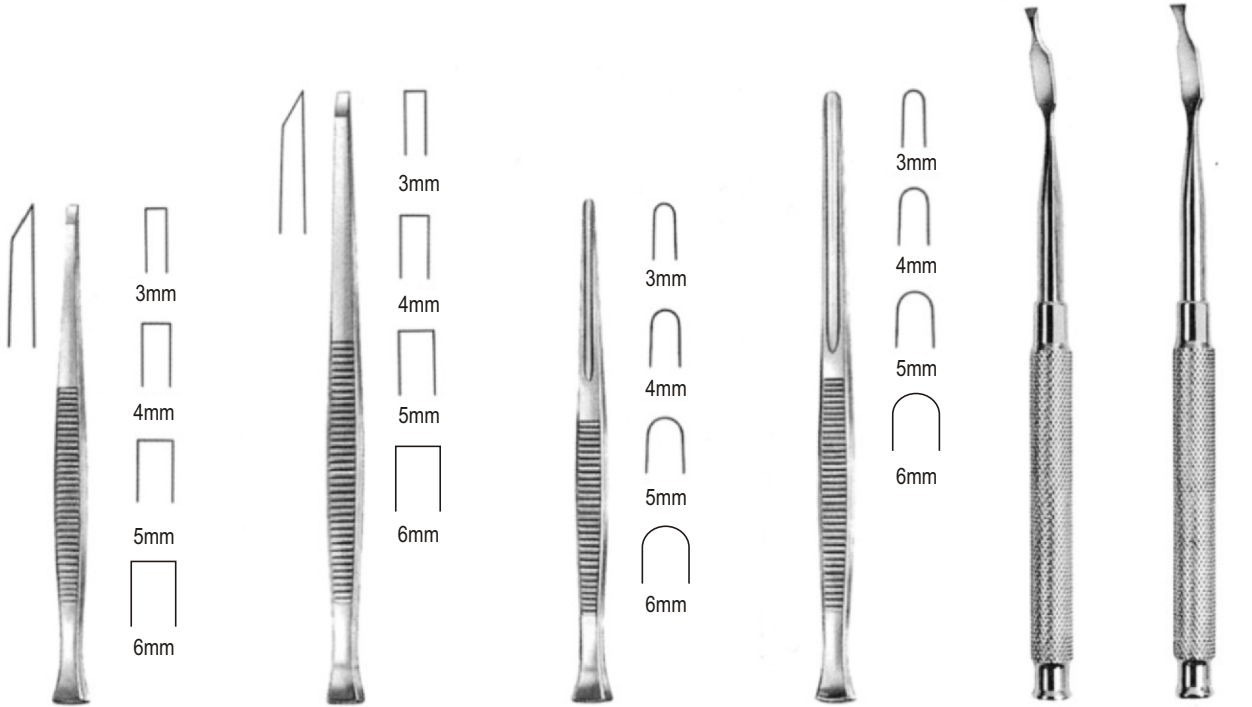

700-233 3mm
700-234 4mm
700-235 5mm
700-236 6mm
Partsch 14cm

700-237 3mm
700-238 4mm
700-239 5mm
700-240 6mm
Partsch 17cm

700-241 3mm
700-242 4mm
700-243 5mm
700-244 6mm
Partsch 14cm

700-245 3mm
700-246 4mm
700-247 5mm
700-248 6mm
Partsch 17cm

700-249
Ochsenbein
16.5cm

700-250
Ochsenbein
16.5cm

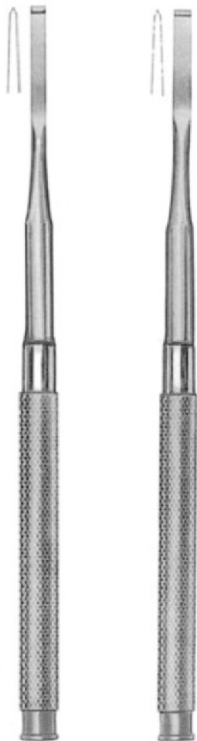

700-251
Wakefield 1W
17cm

700-252
Wakefield 2W
17cm



700-253
Mead Mallet, 7½" (19.1 Cm),
Head 8 Oz. (227 G), 1" Face
Diameter With 2 Replaceable
Nylon Caps & Solid Stainless Handle



700-254
Gerzog Mallet, 7½" (19cm),
Head 8 Oz. (227 G) Lead Filled
Head. 25 X 35mm Head With
Stainless Hollow Handle



700-255
Bone Mallet 7½" Both Side
Nylon Tips At Head,
Stainless Handle



700-256
Lucae Mallet, 7½" (19cm),
Head 9 Oz. (255 G) Made
Of Solid Stainless Handle
& Head



SECTION #08

Bone Rongeurs: Page 65
 Bone Curettes: Page 66 to 67
 Bone Files: Page 68
 Wax Knives / Spatulas Plaster & Alginate: Page 69
 Wax & Modeling Carvers: Page 70

Page 65
 Page 66 to 67
 Page 68
 Page 69
 Page 70

Matrix Retainers & Napkin Holders: Page 71
 Amalgam Carriers: Page 72
 Rubber Dam Instruments: Page 73
 Rubber Dam Clamps: Page 74

Bone Rongeurs

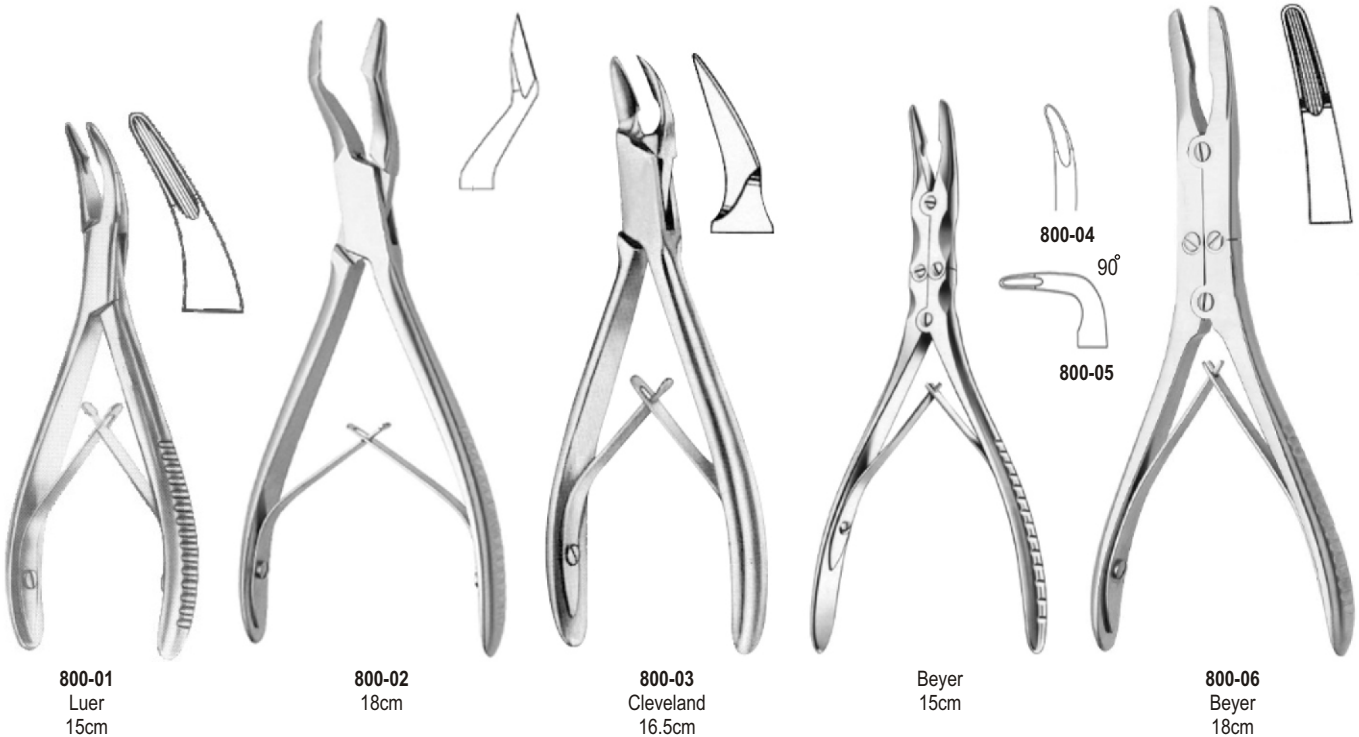

800-01
Luer
15cm

800-02
18cm

800-03
Cleveland
16.5cm

Beyer
15cm

800-06
Beyer
18cm

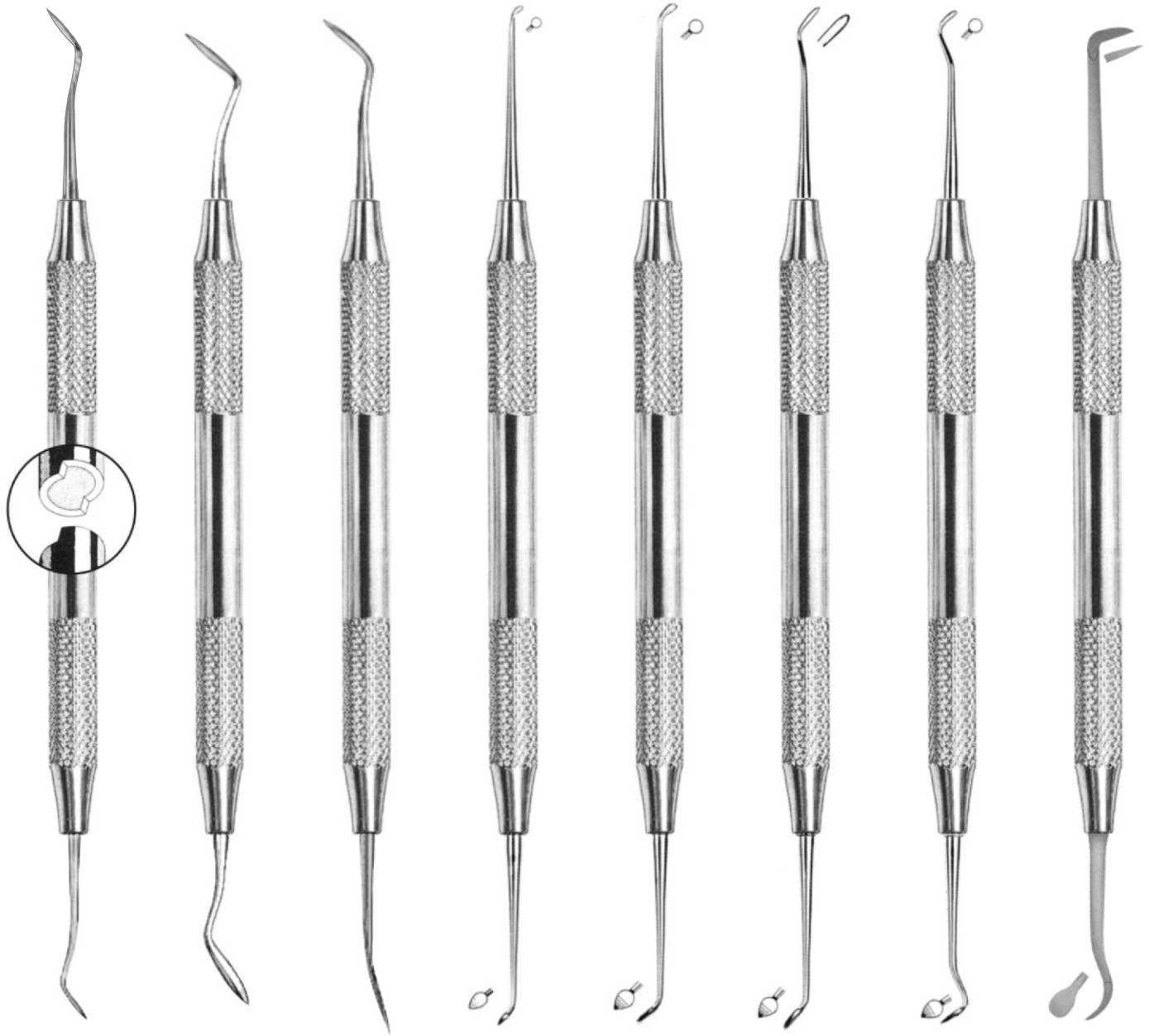

800-07
Hollenback

800-08
Hollenback

800-09
Ward

800-10

800-11

800-12

800-13

800-14

Cleoid - Discoid

Bone Curettes

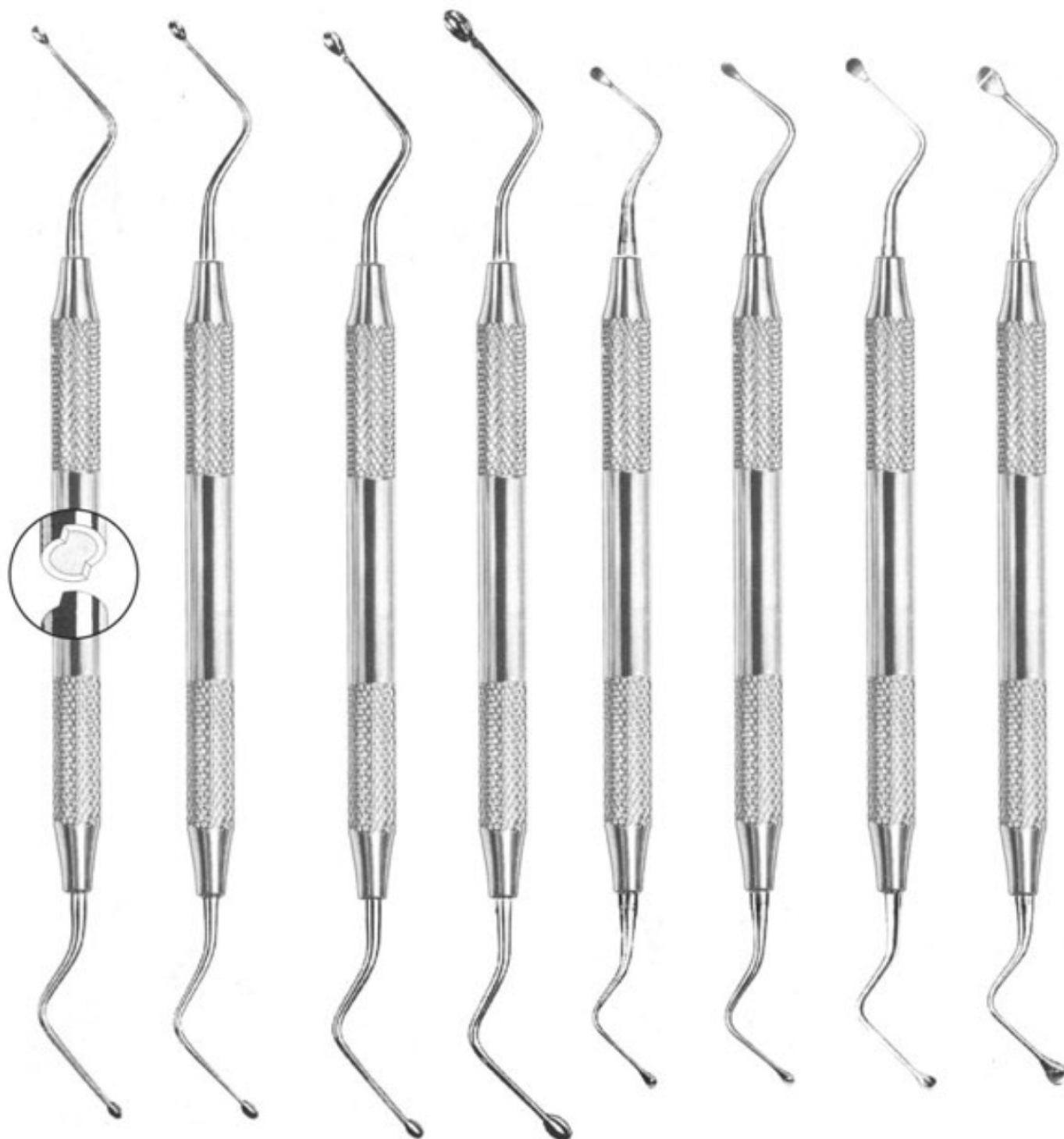

800-15
Hemingway
Fig.1

800-16
Hemingway
Fig.2

800-17
Hemingway
Fig.3

800-18
Hemingway
Fig.4

800-19
Lucas
Fig.1

800-20
Lucas
Fig.2

800-21
Lucas
Fig.3

800-22
Lucas
Fig.4



800-23
Polokoff

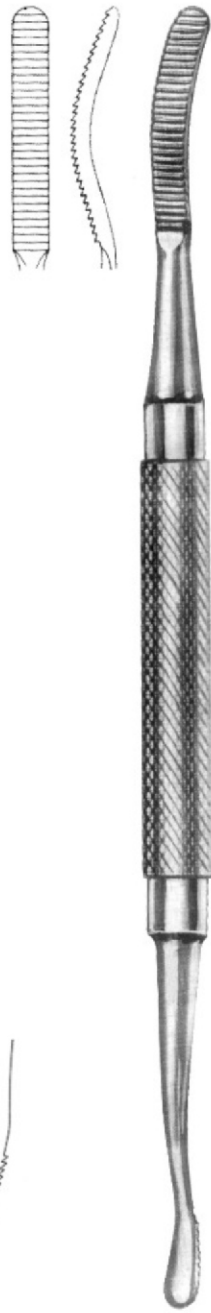

800-24



800-25
Miller



800-26

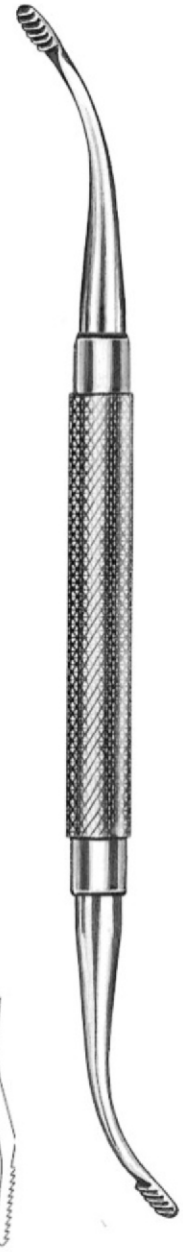

800-27
What

Wax Knives / Spatulas Plaster & Alginate



800-28
Fahnenstock
13cm



800-29
Fahnenstock
17cm



800-30
Lessmann
13cm



800-31
Lessmann
17cm



800-32
16cm



800-33
16cm



800-34
17cm



800-35
21cm



800-36
22cm



800-37
18cm



800-38
17cm



800-39
20cm



800-40
Plaster Shear
21cm



800-41
Hylin



800-42
Hylin-Le-Cron



800-43
Zahle



800-44
Zahle



800-45
Beale



800-46
Le Cron



800-47
Le Cron

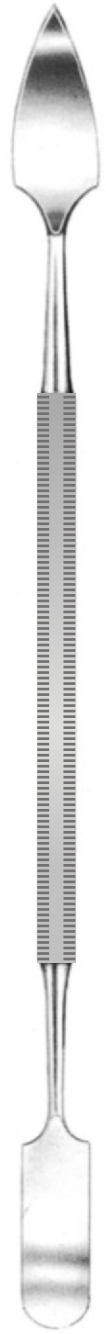

800-48
Gritman

Matrix Retainers & Napkin Holders



800-49 5mm
800-50 6mm
800-51 7mm
Ivory



800-52
6mm



800-53
Universal



800-54
Tofflemire-Junior



800-55
Tofflemire-Senior



800-56
Cheek Protector



800-57
Ivory 8N

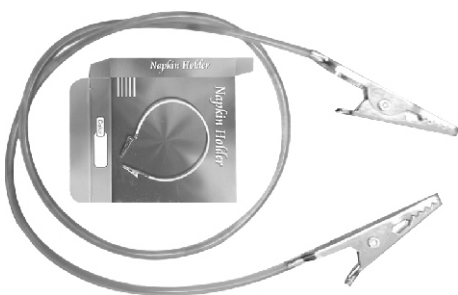

800-58
Napkin Holder With
Plastic Band



800-59
Adam Napkin Holder



800-60
Sjogveland / Ash Narrow



800-61
Sjogveland / Ash Wide



800-61-01
Ivory 8P Didner



800-61-02
Nystrom
Left



800-61-03
Nystrom
Right



800-61-04
Ivory With Out
Protecting Shield



800-61-05
Ivory With
Protecting Shield

Available in Solid / Hollow Handle



800-62
Sml / Med 1.5/2mm
Med / Lrg 2/2.5mm
Med / Jumbo 2/3mm

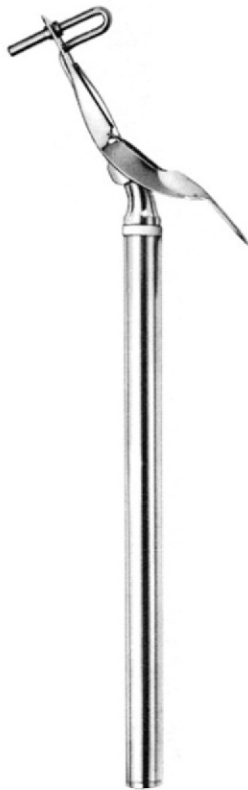

800-63
Contra
Sml 1.5mm
Med 2mm
Lrg 2.5mm
Jumbo 3mm



800-64
Sml 1.5mm
Med 2mm
Lrg 2.5mm
Jumbo 3mm



800-65
mm, 2.00 \varnothing
30°

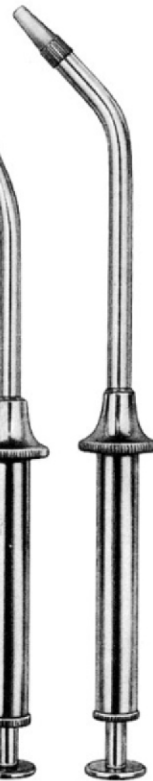

800-66
mm, 2.00 \varnothing
45°

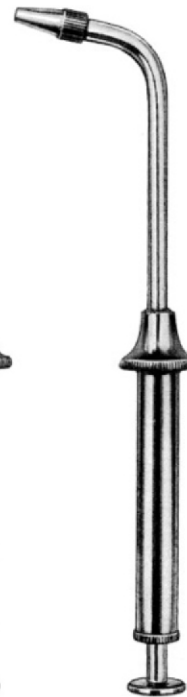

800-67
mm, 2.00 \varnothing
90°



800-68

800-69

12cm



800-70 1.2mm \varnothing
800-71 1.8mm \varnothing

800-72 1.2mm \varnothing
800-73 1.8mm \varnothing

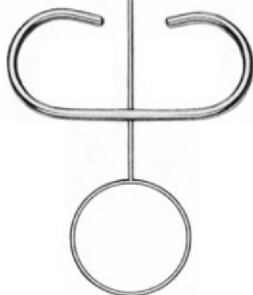

12cm
Bone Carrier

800-74 (14cm) 3mm \varnothing
800-75 (14cm) 4mm \varnothing
800-76 (14cm) 6mm \varnothing
800-77 (19cm) 3mm \varnothing
800-78 (19cm) 4mm \varnothing
800-79 (19cm) 6mm \varnothing

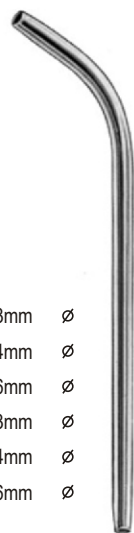

Suction Tubes



800-80
Yankauer
36cm



800-81 2mm \varnothing
800-82 2 2/3mm \varnothing
800-83 3 1/3mm \varnothing
800-84 4mm \varnothing
Frazier / Ferguson
Suction Tube With
Stilette



800-85 (0/1)
800-86 (1/2)
800-87 (3/4)
Bowmann

Rubber Dam Instruments

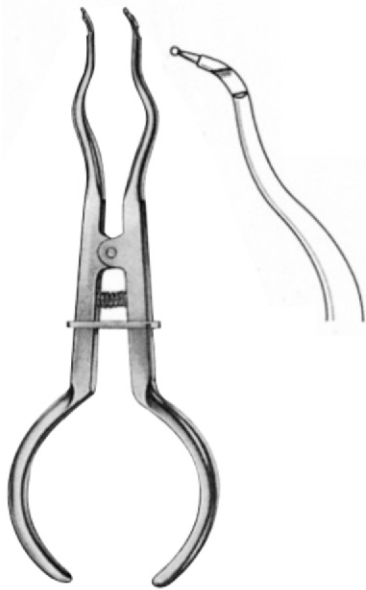

800-123
Brewer
17.5cm



800-124
Stockes
17.5cm

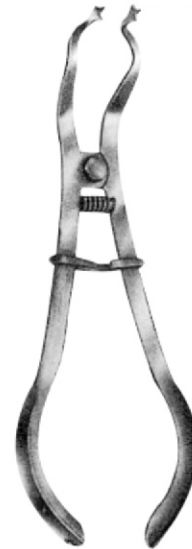

800-125
Ivory
17cm

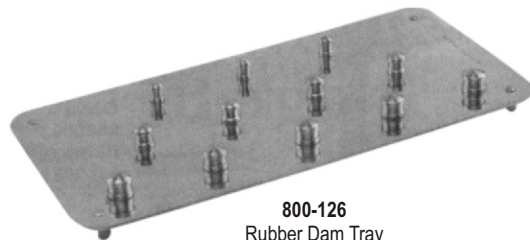

800-126
Rubber Dam Tray



800-127
Ainsworth
16cm



800-128
Ivory
16cm



800-129
Young
105x95mm



800-88



800-89



800-90



800-91



800-92



800-93



800-94



800-95



800-96



800-97



800-98



800-99



800-100



800-101



800-102



800-103



800-104



800-105



800-106



800-107



800-108



800-109



800-110



800-111



800-112



800-113



800-114



800-115



800-116



800-117



800-118



800-119



800-120



800-121

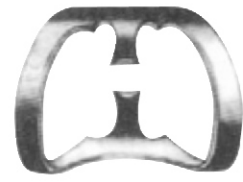

800-122



SECTION #09

Stainless Steel Impression Trays: Page 75 to 77
 Sterilization Cassettes / Trays / Baskets: Page 78 to 79
 Holloware: Page 80 to 81
 Bur Holders / Endo Boxes: Page 82
 Diagnostic Sets: Page 83 to 84

Examination Head Mirrors & Head Lights: Page 85
 Orthodontic instruments: Page 86
 Measuring Instruments: Page 87 to 88
 Mix Instruments: Page 89 to 91
 Dental Keychain: Page 92

Stainless Steel Impression Trays

**All Impression Trays Upper & Lower Type
 are Available In S, M, L & XL Sizes**



900-01
Fig. 0
Per Bambini - For Children

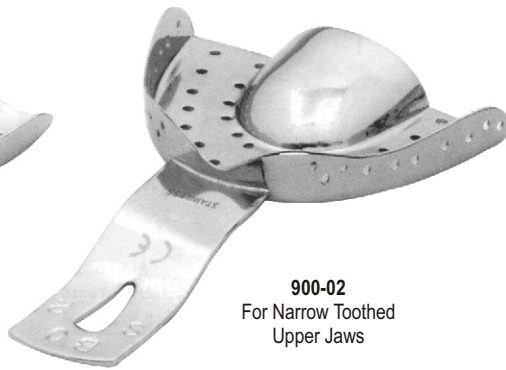

900-02
For Narrow Toothed
Upper Jaws



900-03
Fig. 0
Per Bambini - For Children



900-04
For Partially Toothed Upper Jaws



900-05
For Partially Toothed Lower Jaws

All Impression Trays Upper & Lower Type are Available In S, M, L & XL Sizes



900-06
"HYDRO-LOCK"
Stainless Steel
Water-Cooled Impression
Trays With Retention Rim.



900-07
"HYDRO-LOCK"
Stainless Steel
Water-Cooled Impression
Trays With Retention Rim.



900-08
"NEW SUPER"
Stainless Steel
Impression Trays
With Retention Rim.



900-09
"NEW SUPER"
Stainless Steel
Impression Trays
With Retention Rim.



900-10
"ANATOMIC"
Solid Regular Stainless
Steel Impression Trays
With Retention Rim.



900-11
"ANATOMIC"
Solid Regular Stainless
Steel Impression Trays
With Retention Rim.



900-12
Perforated-total Denture
Stainless Steel Impression
Trays With Rim.



900-13
Perforated-total Denture
Stainless Steel Impression
Trays With Rim.

Stainless Steel Impression Trays

All Impression Trays Upper & Lower Type are Available In S, M, L & XL Sizes



900-14
Solid Total Denture Stainless Steel Impression Trays With Rim.



900-15
Solid Total Denture Stainless Steel Impression Trays With Rim.



900-16
"PERMA-LOCK"
Perforated regular Stainless Steel Impression Trays With Retention Rim.



900-17
"PERMA-LOCK"
Perforated regular Stainless Steel Impression Trays With Retention Rim.



900-18
Perforated Stainless Steel anterior depressed Impression Trays With Retention Rim.



900-19



900-20



900-21



900-22



900-23



900-24



900-25
Perforated Stainless Steel anterior depressed Impression Trays With Retention Rim.



900-26
Perforated Stainless Steel Impression Trays Without Retention Rim for complete denture.



900-27
Perforated Stainless Steel Impression Trays Without Retention Rim for complete denture.

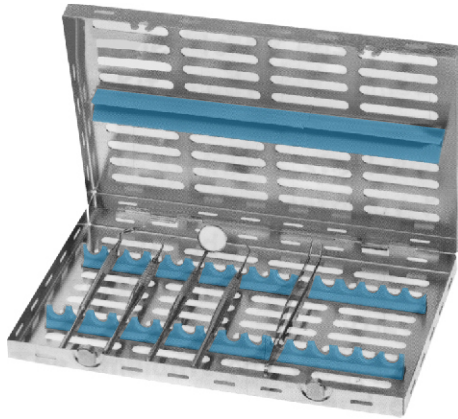

900-28
 Instruments Cassette
 (Removable Cover, Twist Lock System)
 20 Instruments - 280x205x35mm

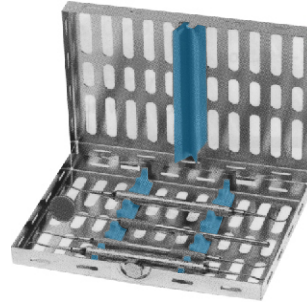

900-29
 Instruments Cassette
 (Removable Cover, Twist Lock System)
 10 Instruments- 185x145x35mm

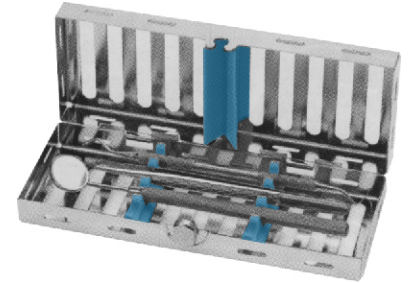

900-30
 Instruments Cassette
 (Removable Cover, Twist Lock System)
 5 Instruments

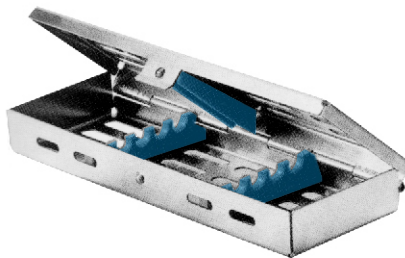

900-31
 Instruments Cassette
 5 Instruments

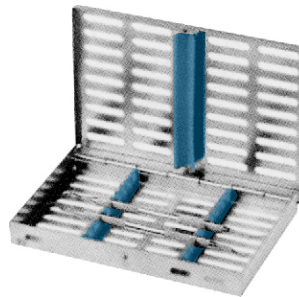

900-32
 Instruments Cassette
 10 Instruments - 188x135x25mm

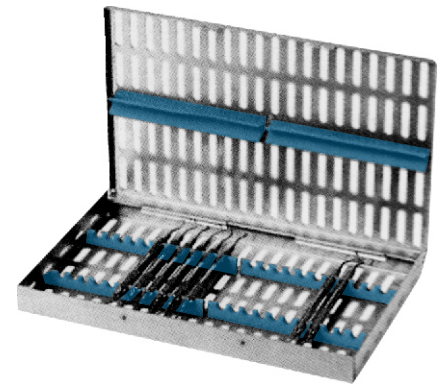

900-33
 Instruments Cassette
 20 Instruments - 280x205x35mm

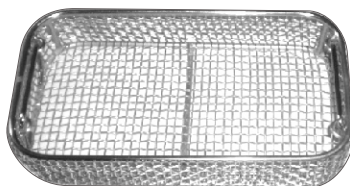

900-34
 Instruments Tray
 240x130x50mm

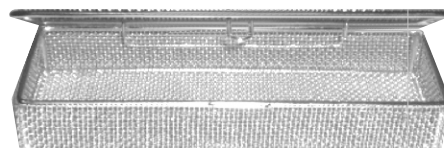

900-35
 Instruments Box
 230x80x40mm

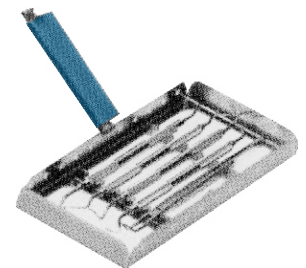

900-36
 Instruments Cassette
 5 Instruments

Sterilization Cassettes / Trays / Baskets



900-37
 Stainless Steel Sterilizing
 Box Includes A Finger Tip Silicone
 Mat Insert To Facilitate Sterilization
 Of Handpieces. Perforated Top Made
 Of Stainless. Dimension 255x155x20mm



900-38
 Stainless Steel Sterilizing
 Box Includes A Finger Tip Silicone
 Mat Insert To Facilitate Sterilization
 Of Handpieces. Dimension 255x155x20mm



900-39
 Made Of Stainless Steel, silicone
 Instrument Holder Medium Cassette
 For 10 Instruments. Silicone Is
 Available In Assorted Colors.
DIMENSION 188x135x22mm

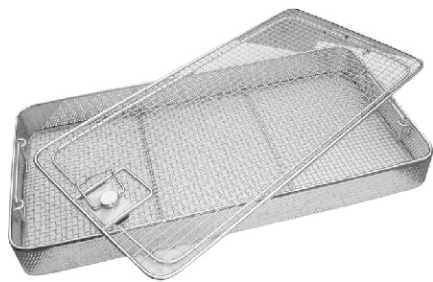

900-40
 Sterilization Basket With
 Cross-hatched Flat Based
 Mesh, Lockable &
 Removable Lid.
DIMENSION: 480x228x55mm

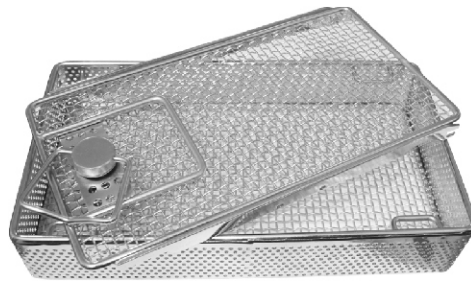

900-41
 The Base Is Crimped Wire
 Mesh With Opening Mesh.
 Cross-hatched Flat Based
 Mesh And Perforated Sides
 and Removable Lid
DIMENSION: 220x125x40mm



900-42
 Sterilization Basket With
 Cross-hatched Flat
 Based Mesh, Lockable &
 Removable Lid.
DIMENSION: 240x250x107mm



900-43
 Sterilization Basket With
 Perforated Sides Crosshatched
 Flat Based Mesh
 With-out Lid.
DIMENSION: 250x235x50mm



900-44
 Sterilization Basket With
 Cross-hatched Flat Based
 Mesh, Lockable &
 Removable Lid.
DIMENSION: 240x250x57mm



900-45
 Sterilization Basket With
 Cross-hatched Flat Based
 Mesh, Lockable &
 Removable Lid.
DIMENSION: 255x228x55mm



900-46
 Solid Sides, Perforated
 Base & Top Is Crimped
 Wire Mesh With Top
 Opening.
DIMENSION: 228x178x35mm



900-47
Ounces
10, 20, 40, 60, 80



900-48
Ounces
40

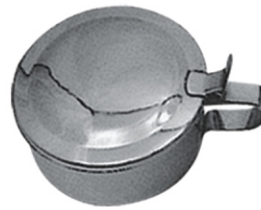

900-49
Spitten Mug



900-50
Spirit Lamp



900-51
Perforated Tray
288 X 187 X 40 mm
180 X 140 X 40 mm



900-52
Perforated Base
288 X 187 X 40 mm
180 X 140 X 40 mm

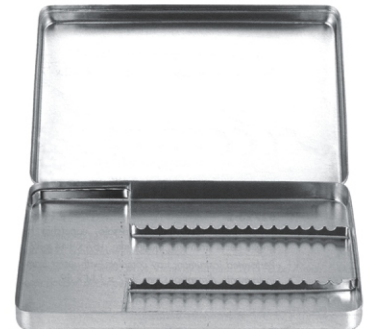

900-53
Solid Base
288 X 187 X 40 mm
180 X 140 X 40 mm



900-54
Instruments Tray
8" X 4" X 1"



900-55
Instruments Tray with Cover
8"X 6" X 2"
10"X 8" X 2"
12"X 7" X 2"



900-56
Instruments Tray Perforated
12"X 6" X 1"



900-57
Instruments Tray Shallow Mayo
8" X 6" X 1
9" X 6" X 1
12" X 8" X 2"



900-58
Scaler Tray
200 X 100 X 15 mm
200 X 150 X 15 mm



900-59
Catheter Tray
222 X 82 X 40 mm
225 X 125 X 50 mm
325 X 90 X 50 mm

Holloware

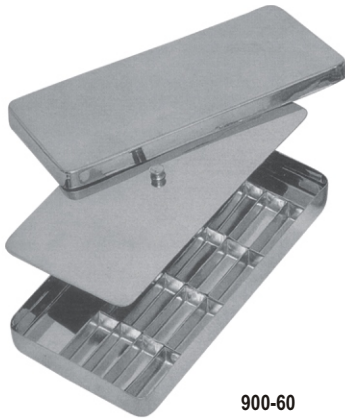

900-60
Endodontic Box
17X17X3 cm / 20X10X4 cm
25X12X6 cm / 30X14X6 cm



900-61
Sterilizing Box
17X17X3 cm / 20X10X4 cm
25X12X6 cm / 30X14X6 cm



900-62
Endo Tray Box



900-63
Instrument Box With Lock
8" X 4" X 1/2" / 8" X 6" X 2"
10" X 6" X 2" / 12" X 6" X 2"
12" X 8" X 2"



900-64
Instrument Box
8" X 4" X 1" / 8" X 6" X 2"
10" X 6" X 2" / 12" X 6" X 2"
12" X 8" X 2"



900-65
Perforated Sterilizing Box
8" X 4" X 1" / 8" X 6" X 2"
10" X 6" X 2" / 12" X 6" X 2"
12" X 8" X 2"



900-66
Sterilizing Drum
6"x5"



900-67
Sterilizing Drum
6"x6"



900-68
Sterilizing Drum
8"x8"



900-69
Irrigator (Douch Can)
1000 ml / 1500 ml / 2000 ml



900-70
Graduated Jug
500 ml / 1000 ml / 2000 ml



900-71
Kidney Tray
Emesis Basins (Deep)
5" 6" 8" 10" 11" 12" 14"



900-72
 Endo Bur Block / Holder
 For 30 Holes. Made Of
 Clinical Grade Of
 Aluminum. Available In
 Assorted Colors



900-73
 Hu Friedy Endodontic Stand
 / Holders For 24 Files &
 Reamers. Made Of Stainless



900-74
 Endo Bur Block / Holder
 With Clinical Grade Of
 Aluminum, For 48 Holes.
 Available In Assorted
 Colors



900-75
 Endo Storage Bur Block / Holder
 With Box For 216 Holes For Burs,
 Files, Reamers, Finger Spreaders,
 Gutta Percha Points, Paper Points
 Etc. Made Of Clinical Grade Of Aluminum.



900-77
 Open Top, Crystal Endo Bur Holders,
 Holds 33 Burs & Reamers. Made
 Of Clinical Grade Pvc



900-76
 Endo Storage Box Holds 72
 Instruments, Aluminum
 Construction, Autoclavable
 Or Dry Heat. Available In
 Assorted Colors.
DIMENSIONS: 4" X 1 1/4" X 2 1/2"



900-78
 Round Endo Storage Bur
 For Burs, Files, Reamers,
 Finger Spreaders, Gutta
 Percha Points, Paper Points
 Etc. Made Of Clinical Grade
 Of Aluminum



900-79
 Endo Bur Block / Holder
 For 15 Holes. Made Of
 Clinical Grade Of
 Aluminum. Available In
 Assorted Colors

Diagnostic Sets

900-80

Conventional Laryngoscope
 Battery Handle: 11.5 cm,
 Mackintosh 02, 03 & 04,
 Miller Blade 02

900-81

Fiber Optic Laryngoscope
 Battery Handle: 11.5 cm,
 Mackintosh 02, 03 & 04,
 Miller Blade 02

900-82

Conventional Laryngoscope
 Battery Handle: 11.5 cm,
 Mackintosh Blades
 02, 03, 04, 05

900-83

Fiber Optic Laryngoscope
 Battery Handle: 11.5 cm,
 Mackintosh Blades
 0, 01, 02, 03 & 04

900-84

ENT Set (Luer Lock)
 Battery Handle: 11.5 cm, Otoscope
 Head With Three Ear Specula, Nasal
 Speculum, Light Carrier, 2 Laryngeal
 Mirrors No 3 & 4 Illuminated Tongue Blade
 Holder, Ophthalmoscope

900-85

ENT Set (Screw Lock)
 Battery Handle: 11.5 cm, Otoscope Head
 With Three Ear Specula, Nasal Speculum,
 Light Carrier, 2 Laryngeal Mirrors No 3 & 4
 Illuminated Tongue Blade Holder,
 Ophthalmoscope 10 Reusable Specula,



900-86
Otoscope Set with
Ophthalmoscope
Battery Handle: 11.5 cm, Type AA
Focussing Device With Three
Reusable Specula



900-87
Otoscope Set (Luer Lock)
Battery Handle: 11.5 cm, One
Otoscope Head Luer Lock,
Three Ear Cannula, One Spare
Bulb

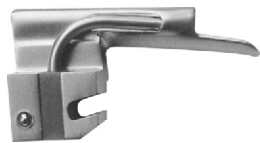

00



01



02



03



04

900-88
Fiber Optic Miller Blades, Also Available In
Conventional Miller Blades



900-89
Mini Fiber Optic Otoscope
Fiber Optic and Illumination
Robust Plastic, Metal Connector,
Plastic Tube Containing 7 Reusable
Specula, Available Colours: Red, Yellow
Black, Blue, Green, Pink & Grey

Examination Head Mirrors & Head Lights



900-90-A
 Clar Head Light Traditional
 Head Light 6 Volt, With
 Adjustable Joint, Black Plastic Head
 Band, With Foam Rubber & 9 Volts
 Re-Chargeable Battery Along-With
 Charger. Head Band is
 Available In Assorted Colors



900-90
 Lead-Free Clar Head Light 9 Volt, With
 Adjustable Joint, Black Plastic Head Band,
 With Foam Rubber & 9 Volts Re-Chargeable
 Battery Along-With Charger. Head Band is
 Available In Assorted Colors



900-91
 Conventional Jansen Head Light With Standard
 Illumination 2.5v, Chrome Plated Head With
 Magnifying Glass. Movable In All Directions By
 Means Of A Joint. Head Band Can Be Adjusted By
 Metal Screw. Supplied With Adaptor. Head Band Is
 Available In Assorted Colors



900-92
 Lead-Free Jansen Head Light With 9 Volts
 Re-chargeable Battery Along- with Charger
 & Standard Illumination 2.5v, Chrome Plated
 Head With Magnifying Glass. Movable In All
 Directions By Means Of A Joint. Head Band
 Can Be Adjusted By Metal Screw. Head Band
 Is Available In Assorted Colors



900-93
 Rexine Head Light 6 Volt, With Adaptor
 220-224 Volts. The Black Rexine Head
 Band Can Be Adjusted to The Individual
 Head Size By Means Of Metal Buckle.
 The Hinge Allows Adjustment Of The
 Bulb In All Directions



900-94
 Laser Head Light With
 Adjustable Joint, Grey
 Plastic Head Band, With
 Foam Rubber. Head Band
 Is Available In Assorted Colors



900-95
 Ziegler Head Mirror
 The Black Plastic Head
 Band Can Be Adjusted To
 The Individual Head Size By
 Means Of The Metal Buckle.
 The Hinge Allows Adjustment
 Of The Mirror, Ø Mm.90, In All
 Direction. Head Band Is
 Available In Assorted Colors

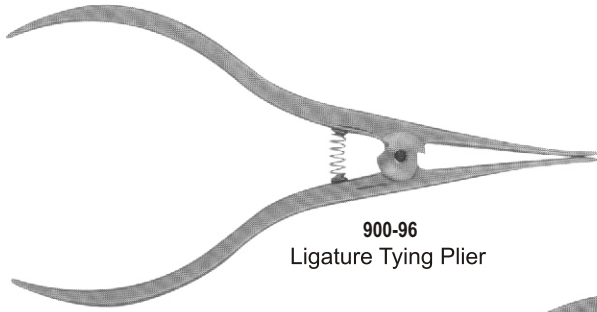

900-96
Ligature Tying Plier

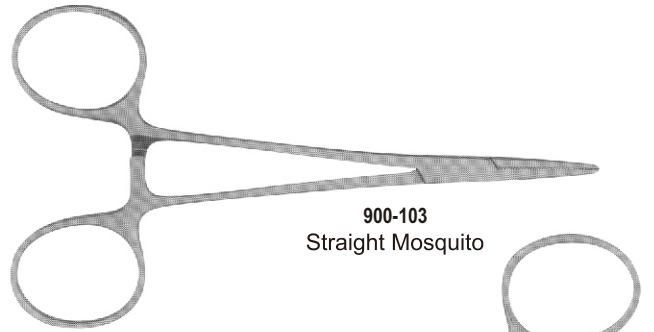

900-103
Straight Mosquito

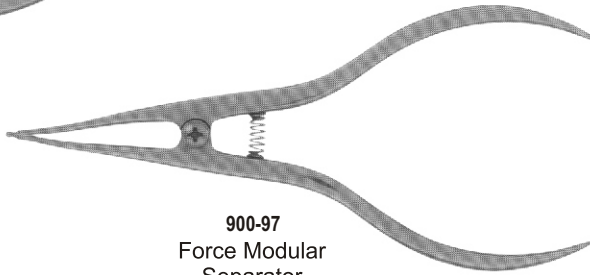

900-97
Force Modular
Separator

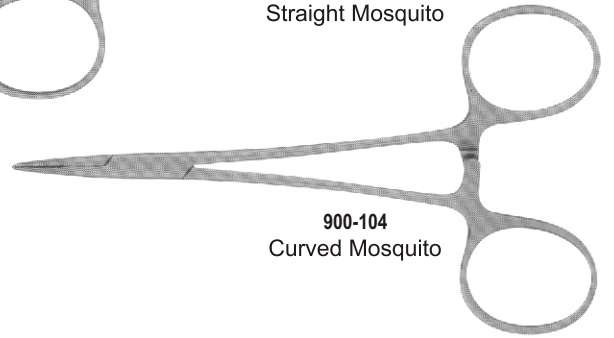

900-104
Curved Mosquito

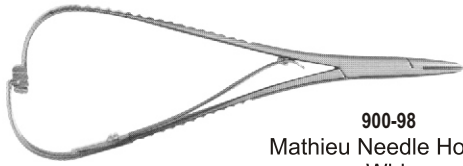

900-98
Mathieu Needle Holder,
Wide



900-105
Boone Gauge
Stainless Steel

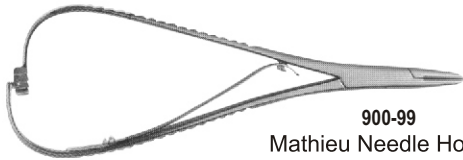

900-99
Mathieu Needle Holder,
Narrow

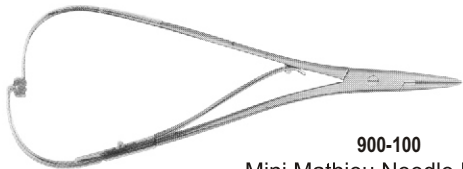

900-100
Mini Mathieu Needle Holder,



900-106
Bracket Height Gauge
No-018

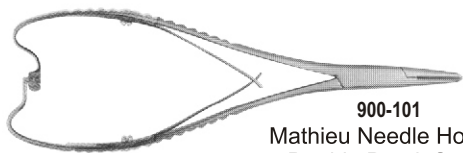

900-101
Mathieu Needle Holder,
Double Bend, Small



900-107
Bracket Height Gauge
No-022

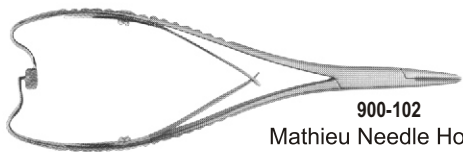

900-102
Mathieu Needle Holder,
Double Bend, Large



900-108
Swivel Head Bracket
Height Gauge
Dimensions: 3.5; 4.0; 4.5
& 5.0mm



900-109
Mouth Mirror
With Handle

Measuring Instruments



900-110
 Orthodontic Caliper
 Beerendonk D/E. Both Side
 Graduation 0-8mm Scale

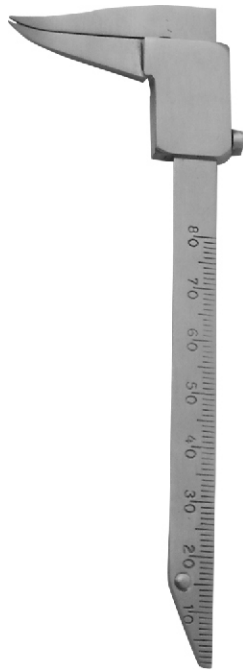

900-111
 Orthodontic Caliper
 Beerendonk S/E.
 Both Side Graduation
 0-8mm Scale



900-112
 Sensory Caliper
 (Vernier Caliper)
 With Plastic Tip 20cm



900-113
 Sensory Caliper
 (Vernier Caliper)
 With Plastic Tip 10cm



900-114
 Finger Goniometer
 3 Joint Measuring
 Range 180°

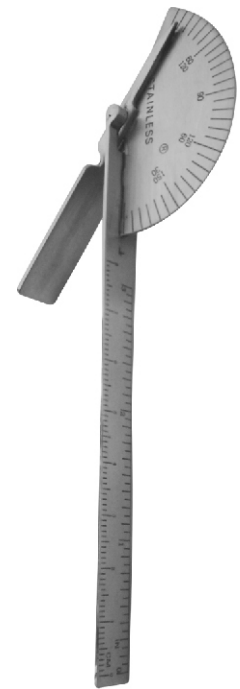

900-115
 Caroll Pocket Goniometer
 6" Long With 180° Scale
 In 5° Increments. Fixed
 Leg Has 5" Linear Scale
 Calibrated In Inches &
 Centimeters



900-116
 Wills Bit Gauge
 Scale 0-100mm
 Both Side Graduation



900-117
 Wills Bit Gauge
 Scale 0-40mm

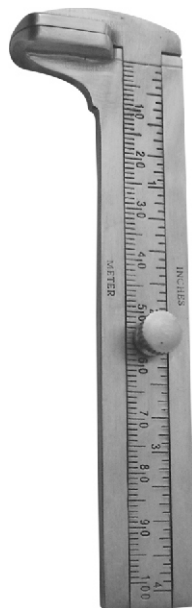

900-118
 Jaguar Caliper Measuring
 Range 0-100mm (3-1/4")
 Measures in Millimeters
 & Inches



900-119
 Townley Caliper Measuring
 Range 0-100mm Measures
 in Millimeters & Inches



900-120
 Jameson Caliper
 Measuring Range
 0-90mm Measures in
 Millimeters & Inches



900-121
Wide Throat Lens Thickness Gauge Accommodates Lens Blanks Of Over 90mm Diameter & 22mm in Thickness. 47mm Throat Depth, 0.1mm Graduations. Overall Length 9-3/4"



900-122
Lens Thickness Gauge Measures Up To 25mm Thick Lenses In 1/5mm Graduations. 7 1/2" Long



900-123
Wide Mouth Lens Gauge Measures Up To 25mm Thick Lenses In 1/5mm Graduations. 7 1/2" Long



900-124
Small Mouth / Jaw Lens Gauge Measures Up To 25mm Thick Lenses In 1/5mm Graduations. 7 1/2" Long



900-125
Degree Gauge For Jewelry Degree Gauge For Jewelers, Machinists, Electronics, Auto Mechanics & Measuring

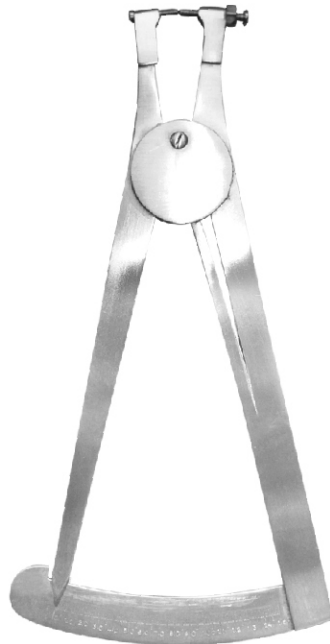

900-126
Wide Jaw Lens Gauge Measures Up To 25mm Thick Lenses In 1/5mm Graduations. 7 1/2" Long



900-127
Finger Endo Ruler Sliding



900-128
Finger Endo Ruler- Etched



900-129
Wire Gauge Popular Gauge For Gauging Iron Wire Hot & Cold Rolled Sheet Steel

Mix Instruments



900-130
Corn Cutter



900-131
Corn Cutter - Plastic handle



900-132
Corn Cutter - Plastic handle



900-133
Corn Cutter - Plastic handle

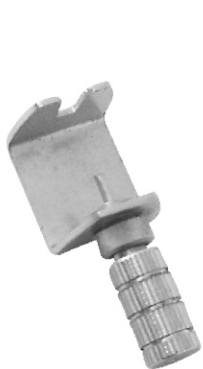

900-134
Universal Bur Changer
Wrench



900-135
Dentaire Bur Changer
Wrench

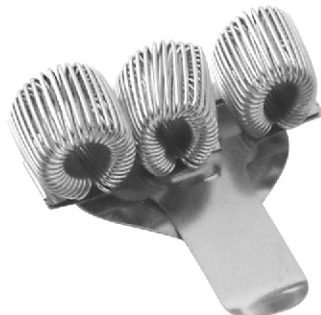

900-136
Pocket Instruments
Holder



900-137
Bow Caliper 8 (Compass)



900-138
Diamond Disc Guard
with Adapter



900-139
Caliper Eight Gauge



900-140
Optical Inspection Stand

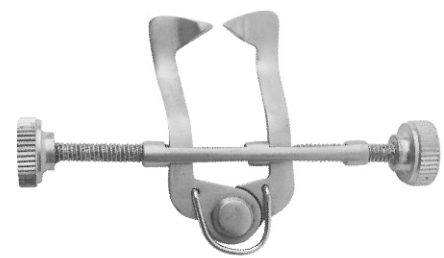

900-141
Matrix Retainer Elliott
Separator



900-142
Gem Holder / Bead Holder



900-143
Tongue Depressor
Small, Large



900-144
Ring Bending Pliers Swiss
Model 190mm



900-145
Denture Alloy Flask Set
Upper/Lower Denture &
Bench Press



900-146
Mesh Bur Holder



900-151
Feline Mouth Gag For Cats
With Nylon Inserts
Available in 2 Sizes Small 2.5"
Large 3"



900-148
X-Ray Film Holder



900-152
Canine Spring Action
Mouth Gag With Nylon Inserts
Available in 3 Sizes Small 4.5"
Medium 5.25"
Large 7"



900-147
Stripholder Clips



900-149
Radiography Clip

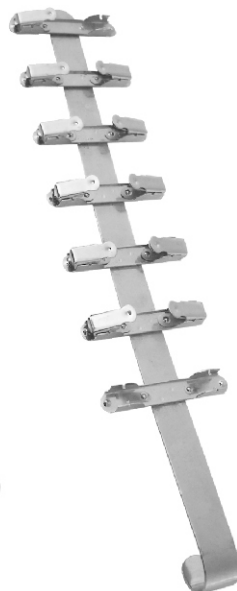

900-150
X-Ray Film hangers Multiple Clips
Available in 6, 8, 10, 12 & 14 Clips

Mix Instruments



900-153
Protractor Goniometer
Two Opposing 180 Degree
Scales & One 360 Degree
Scale, All Marked In 1 Degree
Increments. Tension Between
Arms Controlled By A Thumb
Knob. 14" (35cm) Long



900-154
Finger Goniometer 180°
Two 180° scale in opposite
direction for convenient
reading of all angles. Nickel
chromium plated

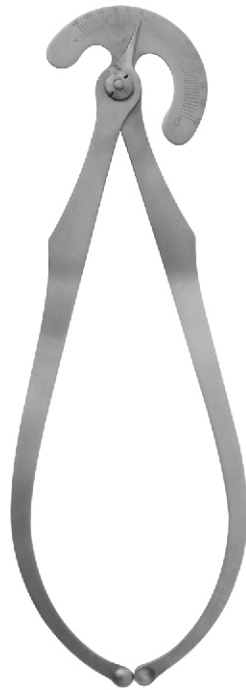

900-155
Collin's Pelvimeter For
Measuring Angles,
Diameters & Body
Cavities 340mm, 13½",
35cm



900-156
Goniometer - Thole
Measuring Of Angles,
Diameters & Body Cavities.
340mm & 13½"



900-157
Goniometer Moltgen
Measuring Range
0-180mm



900-158
Bertillon Caliper
Measuring The
Head 320mm, 12¾"



900-159
Endo File Holder



900-160
Eggen Holders Left



900-161
Eggen Holders Straight



900-162
Eggen Holders Right



900-145
 Upper / Lower Denture Flask & Bench Press Denture Flask Set Feature Forged Brass Alloy Construction. Fitted With Hardened Stainless Steel Alloy Rear Tapered Guide Pins. Flask Dimensions: 4" Long X 3 3/4" Wide X 2 1/4" High (10cm X 10cm X 6cm) Unit Weight: 3.850kg Including (upper / Lower Flask & Bench Press)



900-145-A
 Small Denture Flask & Bench Press Denture Flask Set Feature Forged Brass Alloy Construction. Fitted With Hardened Stainless Steel Alloy Rear Tapered Guide Pins. Flask Dimensions: 4" Long X 3 3/4" Wide X 2 1/4" High (10cm X 10cm X 6cm). Unit Weight: 2.425kg Including (flask & Bench Press)



900-145-B
 Flat Bench Press For 2 Denture Flasks (upper+lower). Dimension: 20x12.75x8cm & Unit Weight is 2.175kg

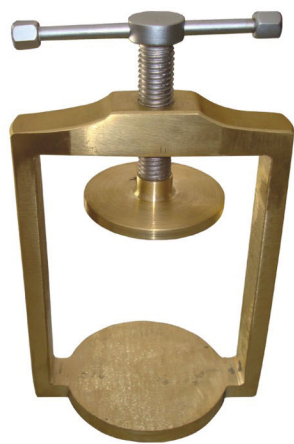

900-145-C
 Alloy Brass Round Bench Press For 2 Flask. Dimension: 7"x5"x3 1/2" & Unit Weight 1.900kg



900-145-D
 Small Denture Bench Press For Single Flask. Brass Alloy Construction Dimension: 5"x3"x4 3/4" & Unit Weight 1.500kg



900-145-E
 Large Denture Flasks & Bench Press. Denture Flask Set Feature Forged Brass Alloy Construction. Flask Dimension: 4"x4 1/2"x2 1/2" & Weight 1.100kg Each Unit Weight: 5.750kg Including (3 Flasks & Bench Press)



900-145-F
 Large Bench Press For 3 Flasks. Featured Forged Brass Alloy Construction. Dimension: 29 X 14 X 9 cm Unit Weight: Weight 2.800kg



900-145-V
 Round Denture Flask Are Made In Superior Gunmetal & Brass. The Round Flasks Are Appropriate For Curing Acrylic Dentures. Dimension: 4"x4 1/2"x2 1/2" And Weight 1.100kg



900-145-Vi
 Mortimer Silverline Alloy Flask. Forged Silver Alloy Construction. Dimension: 4 1/4" Long X 4" Wide X 2 3/4" High (11 X 10 X 7cm) Unit Weight = 750gram



900-145-Xi
 Crown Flask For Dental Tooth. Forged Brass Alloy Construction. Unit Weight: 365gram

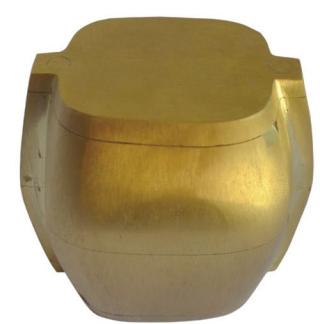

900-145-Xii
 Forged Brass Toothed Dental Alloy Flask For Single Tooth. Dimension: 5.0 X 5.5 X 4.0 Cm & Unit Weight 270 grams

Denture Alloy Flasks & Press



900-145-i
Upper Denture Flask Forged Brass Alloy Construction. Fitted With Hardened Stainless Steel Alloy Rear Tapered Guide Pins. Dimension: 4" Long X 3 3/4" Wide X 2 1/4" High (10cm X 10cm X 6cm) & Weight: 0.920kg



900-145-ii
Lower Denture Flask Forged Brass Alloy Construction. Fitted With Hardened Stainless Steel Alloy Rear Tapered Guide Pins. Dimension: 4" Long X 3 3/4" Wide X 2 1/4" High (10cm X 10cm X 6cm) & Weight: 0.920kg



900-145-iii
Upper Denture Flask Forged Silver Alloy Construction. Fitted With Hardened Stainless Steel Alloy Rear Tapered Guide Pins. Dimension: 4" Long X 3 3/4" Wide X 2 1/4" High (10cm X 10cm X 6cm)

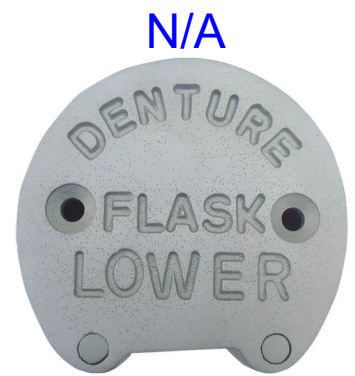

900-145-iv
Lower Denture Flask Forged Silver Alloy Construction. Fitted With Hardened Stainless Steel Alloy Rear Tapered Guide Pins. Dimension: 4" Long X 3 3/4" Wide X 2 1/4" High (10cm X 10cm X 6cm)



900-145-XiV
Upper / Lower Hanau Denture Flask. Forged Brass Alloy Construction. Fitted With Hardened Stainless Steel Alloy Rear Tapered Guide Pins. Dimension: 10 x 8 x 16 cm wide x 2 1/4" Long x 3 3/4"



900-145-Xiii
Silverline Alloy Flask. Forged Silver Alloy Construction. Dimension: 4 1/4" Long X 4" Wide X 2 3/4" High (11 X 10 X 7cm) Unit Weight = 760gram



900-145-X
Butter Dish Silver Alloy Denture Flask. Dimension: 10 x 8 x 16 cm Unit Weight = 760gram



900-145-Vii
One Side Flat Brass Flask. New Shape. Forged Brass Alloy Construction. Dimension: 2 1/4"x3 1/2"x4 3/4" & Unit Weight 955gram



900-145-Xi
Square Dental Alloy Flask. Pressure Die Casted, Made of Brass. Dimension: 7.2 x 8.4 x 5.0 cm Unit Weight: 1.300kg



900-145-Viii
Flask Knock-out Disc Forged Brass Alloy Construction

All Pliers & Cutters Could Be Provided
In Adjustable Lap Joint Fitting,
Box Joint Fitting & Lap Joint Fitting.

All Pliers and Cutters are available
with Tungsten Carbide Tips.

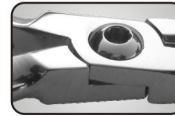

Screw Lock
Box = S/L

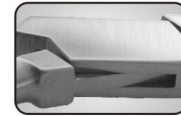

Box Lock = B/L

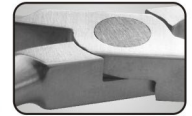

Allen Wrench
Box = AW/L



20-01
Arch Forming and
Contouring Plier

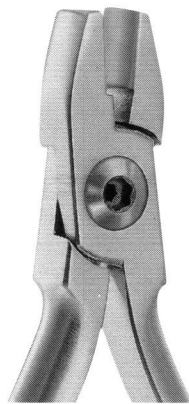

20-02
Arch Forming Plier,
Without Grooves



20-03
Three Jaw Plier, Aderer



20-04
Hollow chop Arch
Forming Plier



20-05
Bird Beak Plier



20-06
Tweed Loop Forming
Plier (1 Piece)



20-07
Light Wire Plier



20-08
Light wire Plier With
Groove



20-09
Light Wire Plier with short
beaks / "Super-Looper"



20-010
Loop Closing Plier,
Nance Style



20-011
Rectangular Arch / Ribbon
Arch Plier

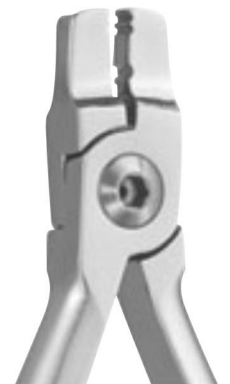

20-12
Lingual Arch Plier

Orthodontic Pliers

All Pliers & Cutters Could Be Provided In Adjustable Lap Joint Fitting, Box Joint Fitting & Lap Joint Fitting.

All Pliers and Cutters are available with Tungsten Carbide Tips.

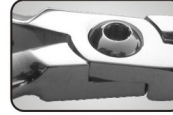

Screw Lock
Box = S/L

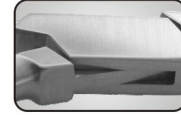

Box Lock = B/L

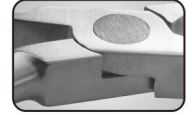

Allen Wrench
Box = AW/L

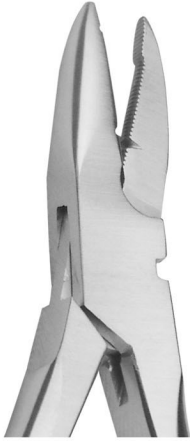

20-13
Waldsachs

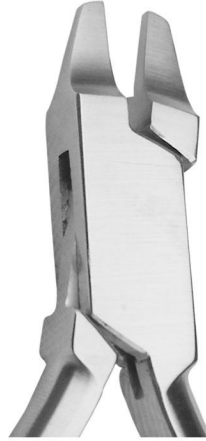

20-14
Ractangular Arch
Formin Plier



20-15
How - Angled



20-16
Angled Bracket
Removing Plier



20-17
Reynolds Contouring
Plier



20-18
Adhesive Removing
Plier



20-19
Posterior Band
Removing Plier

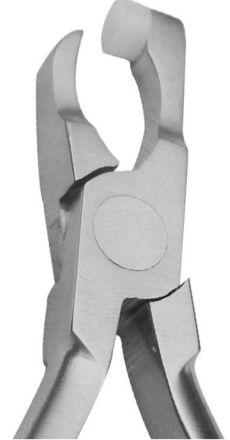

20-20
Posterior Band
Removing Plier-short



20-21
Standard How Utility
Plier Rounded

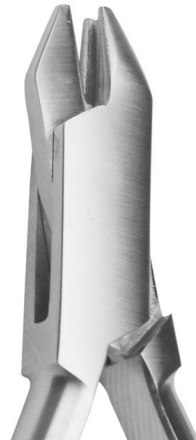

20-22
Aderer - Heavy



20-23
Standard How Utility
Plier



20-24
Aderer

All Pliers & Cutters Could Be Provided In Adjustable Lap Joint Fitting, Box Joint Fitting & Lap Joint Fitting.

All Pliers and Cutters are available with Tungsten Carbide Tips.

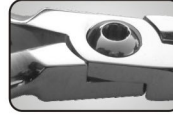

Screw Lock
Box = S/L

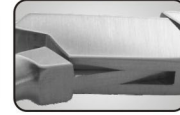

Box Lock = B/L

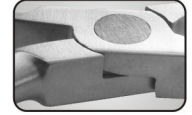

Allen Wrench
Box = AW/L

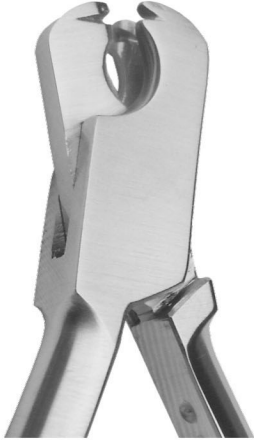

20-25
Aderer



20-26
Flush Cut Distal End Cutler
With Safety Itold



20-27
Model Marburg



20-28
Peeso



20-29
Schwarz

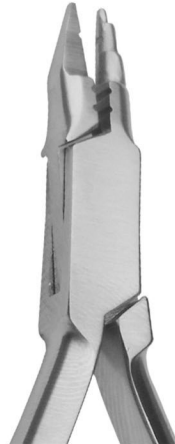

20-30
young



20-31
Loop Forming Plier
Tweed Style



20-32
Serrated Bird Beak
With



20-33
Tweed



20-34
Three Jaws
Round Plier (Olier)



20-35
Nance



20-36
Niti Cinch Black Plier

Students Dental Kits

Basic Tartar Scrapping Kit (4 pcs kit) (03-03-01)



Mouth Mirror Handle With Mirrors Probe 17/23 Towner-Jacquette U15/30 College 15cm

Dental Examination Kit (6 pcs kit) (03-03-02)



Mouth Mirror Explorers 17/23 Explorers 11/12 OUD Williams Probe & Explorers College 15cm Mariem 16.5cm

Dentist's Daily Kit (3 pcs kit) (03-03-03)



Explorers 17/23 Mouth Mirror College 15cm

Dental Laboratory Technicians Kit (10 pcs kit) (03-03-04)



P.K Thomas Fig. 1 P.K Thomas Fig. 2 P.K Thomas Fig. 3 P.K Thomas Fig. 4 P.K Thomas Fig. 5 Fahnstock 13cm Fahnstock 17cm Gritman 17.5cm Zahle Zahle

Plastic Filling Instruments Kit (5 pcs kit)
(03-03-05)

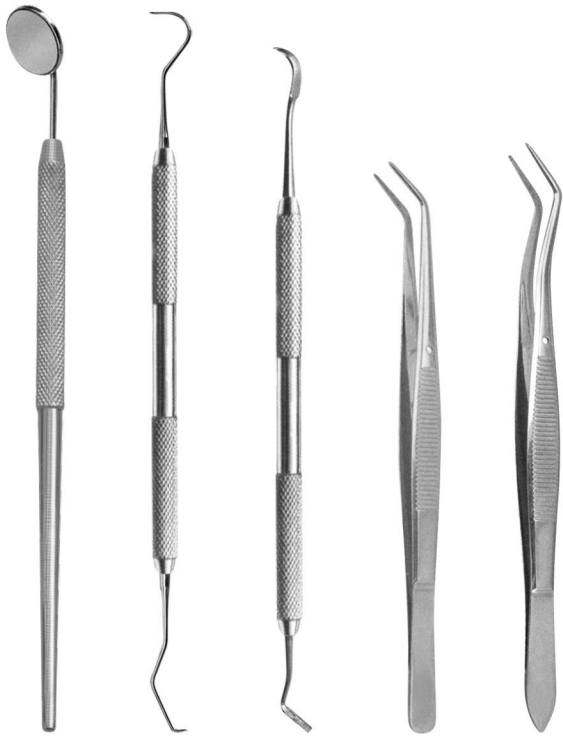

Dental Mirror #4 Explorers 17/23 Plastic Filling Inst 2mm/2mm College 15cm Mariem 16.5cm

Periodontal Examination Kit (6 pcs kit)
(03-03-06)



Mouth Mirror Explorers 17/23 Explorers 11/12 OUD Nabers Probe 2N Probe CP15 1-15mm College 15cm

Basic Rubber Dam Kit (8 pcs kit)
(03-03-07)



Ivory Punch Ivory Light Weight Forceps Rubber Dam Frame 6"

Microsurgery Basic Kit (4 pcs kit)
(03-03-08)

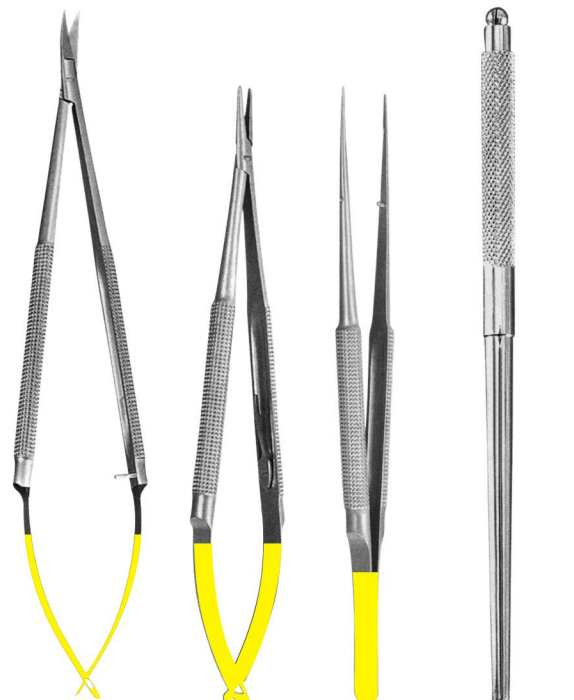

Castroviejo Scissors 14cm Curved Castroviejo Needle Holder TC 14cm Microsurgery Forceps 15cm Curved Microsurgery Scalpel Handle

Dental Implants Instruments

Concave Osteotome With Adjustable



02-17
Dental Osteotomes (10 pcs kit)

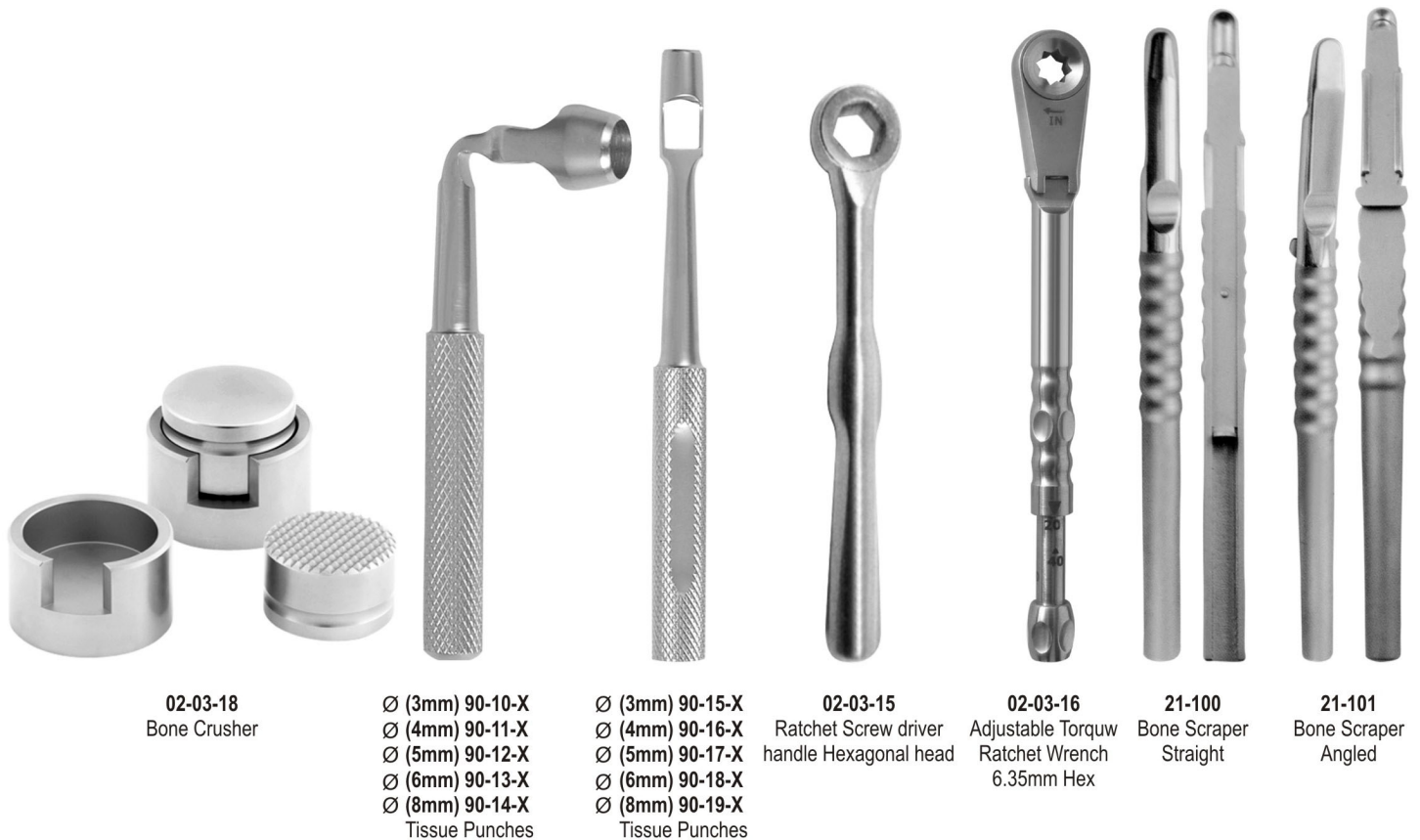



900-163
Mouth Mirror Keychains



900-164
Mouth Mirror Keychains



900-165
Mouth Mirror Keychains

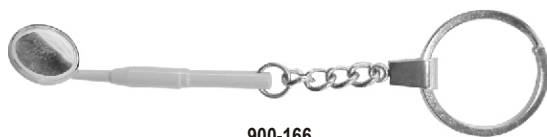

900-166
Mouth Mirror Keychains



900-16
Tweezer Keychains



900-168
Dental Tooth Keychains



900-169
Extracting Forceps Keychains

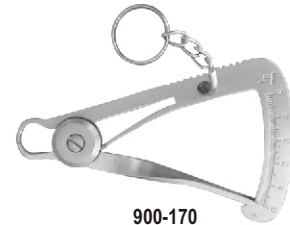

900-170
Dental Caliper Keychains



900-171

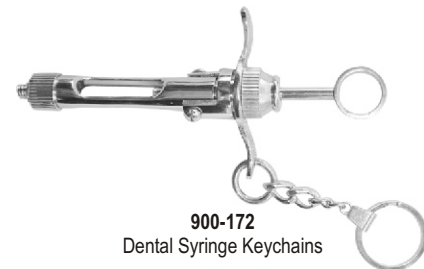

900-172
Dental Syringe Keychains

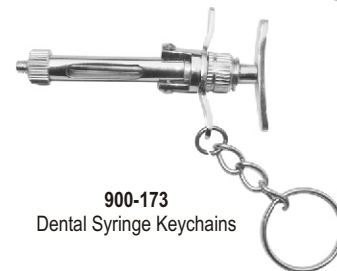

900-173
Dental Syringe Keychains



900-174
Impression Tray Keychains



A: Flat 2, 51 Queens Road, LE2 1WQ
LEICESTER - UK
M: +44 77 60 89 53 07 / +44 11 62 10 26 34
E: info@pintechins.co.uk
W: www.pintechins.co.uk



A: 291 Mohallah East Bhopalwala,
The: Sambrial, Sialkot.
P: +92 52 6502101, +92 52 6913650, +92 345 6733440
E: info@pintech.com.pk
W: www.pintech.com.pk